

5.5x9ft Dome Climber -- 3 Frequency 5/8 Dome Assembly Instructions

Inventory

• 61 Hub Units Total

x40 Hexagon hubs (6 point)

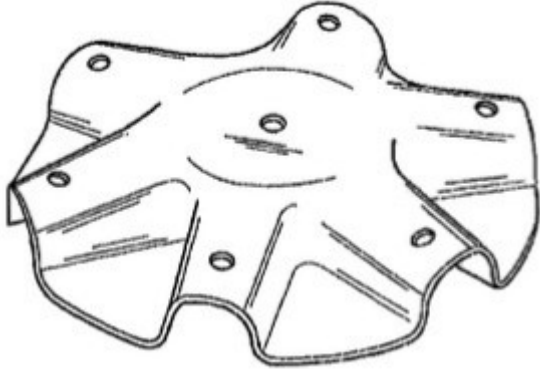

x6 Pentagon Hubs (5 point)

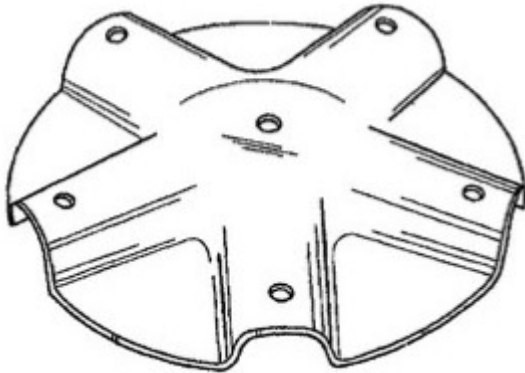

15 Quad hubs (4 point)

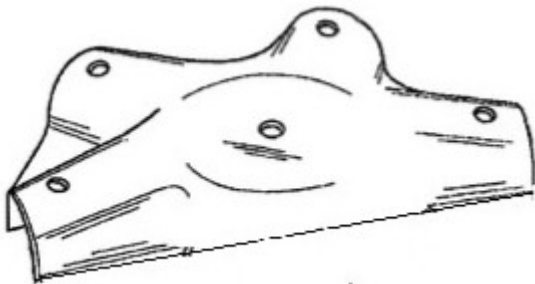

• 165 PVC Pipes

x80 Green tip 

x55 Blue tip 

x30 Red tip 

• 330 Nuts and Bolts

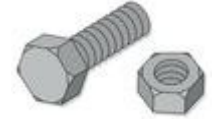

Quick Overview of Hub Unit Assembly Procedure

Its a 2 phase process. The first phase you will just get everything assembled loosely in place with a bolt and nut attaching the pipe to the hub. The second phase after all the segments are in place is where the segments are locked into place by tightening the nuts with a cordless drill or wrench with 7/16" socket.

The pipes have writing on one side, Attach the pipes to dome so the writing is facing towards the center inside of the dome. That way, from outside the dome the writing will not be visible.

What else you will need:

- Cordless drill or wrench with 7/16" socket or equivalent that will tightens 1/4" nuts
- 4 to 5 hours Assembly Time
- Recommended rubber coated knit gloves and safety glasses.

Step 1

a. Set aside:

x15 -- 4pt hubs

x5 -- blue tip pipes

x10 -- green tip pipes

c. Assemble the hub connections. Attach pipe to hub with bolt and nut just hand tighten the nut onto each bolt.

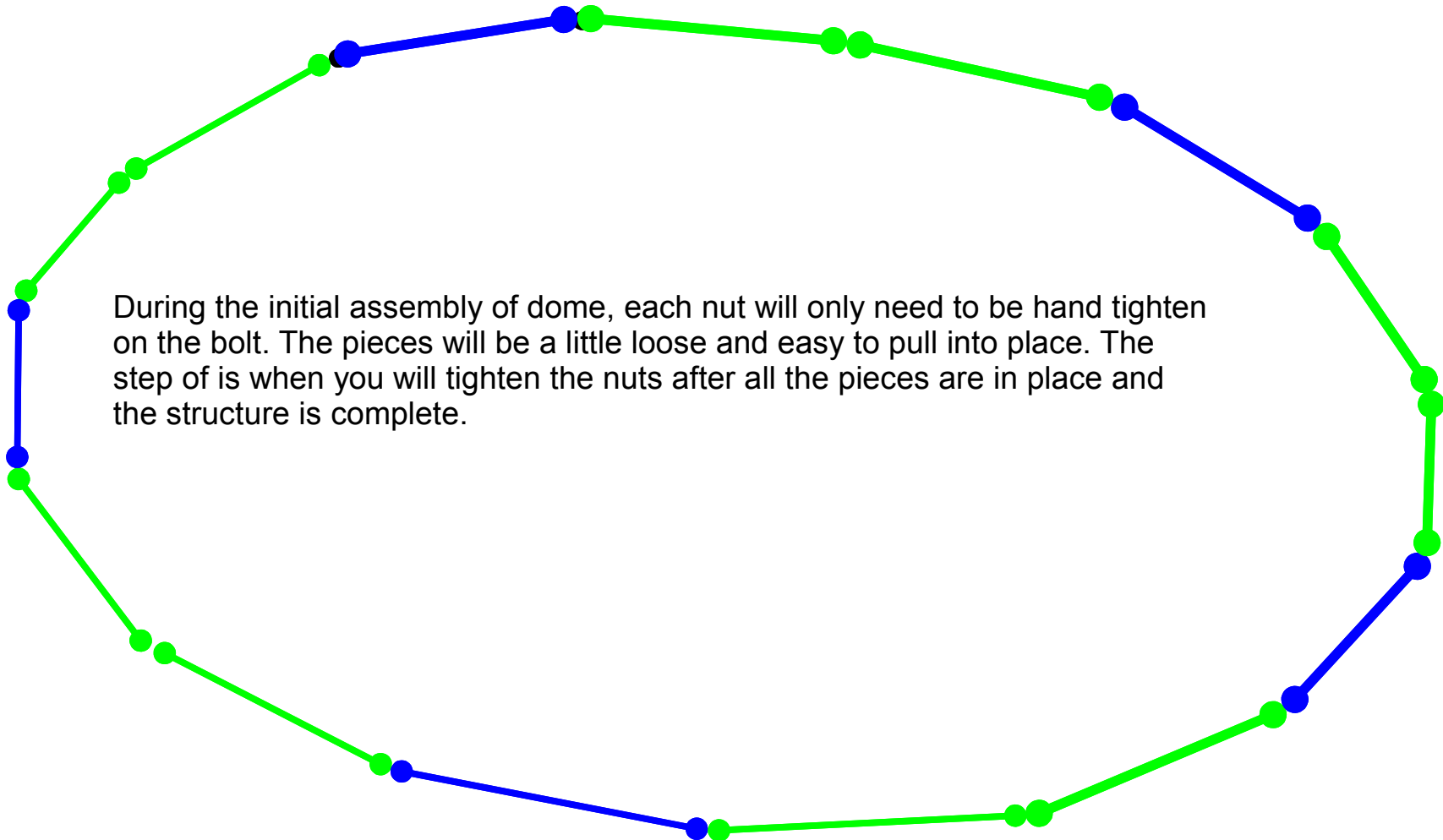

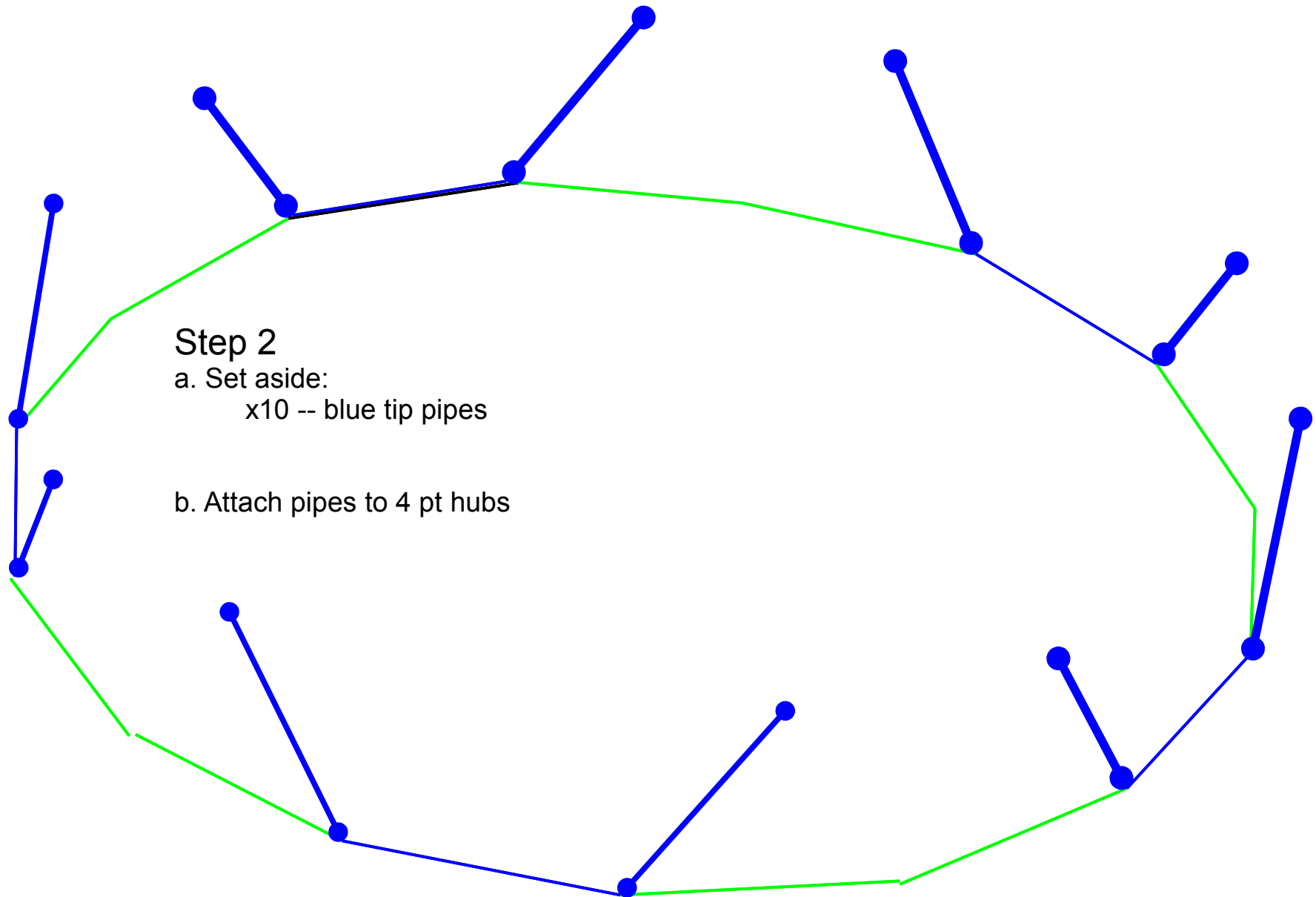

Step 2

a. Set aside:
x10 -- blue tip pipes

b. Attach pipes to 4 pt hubs

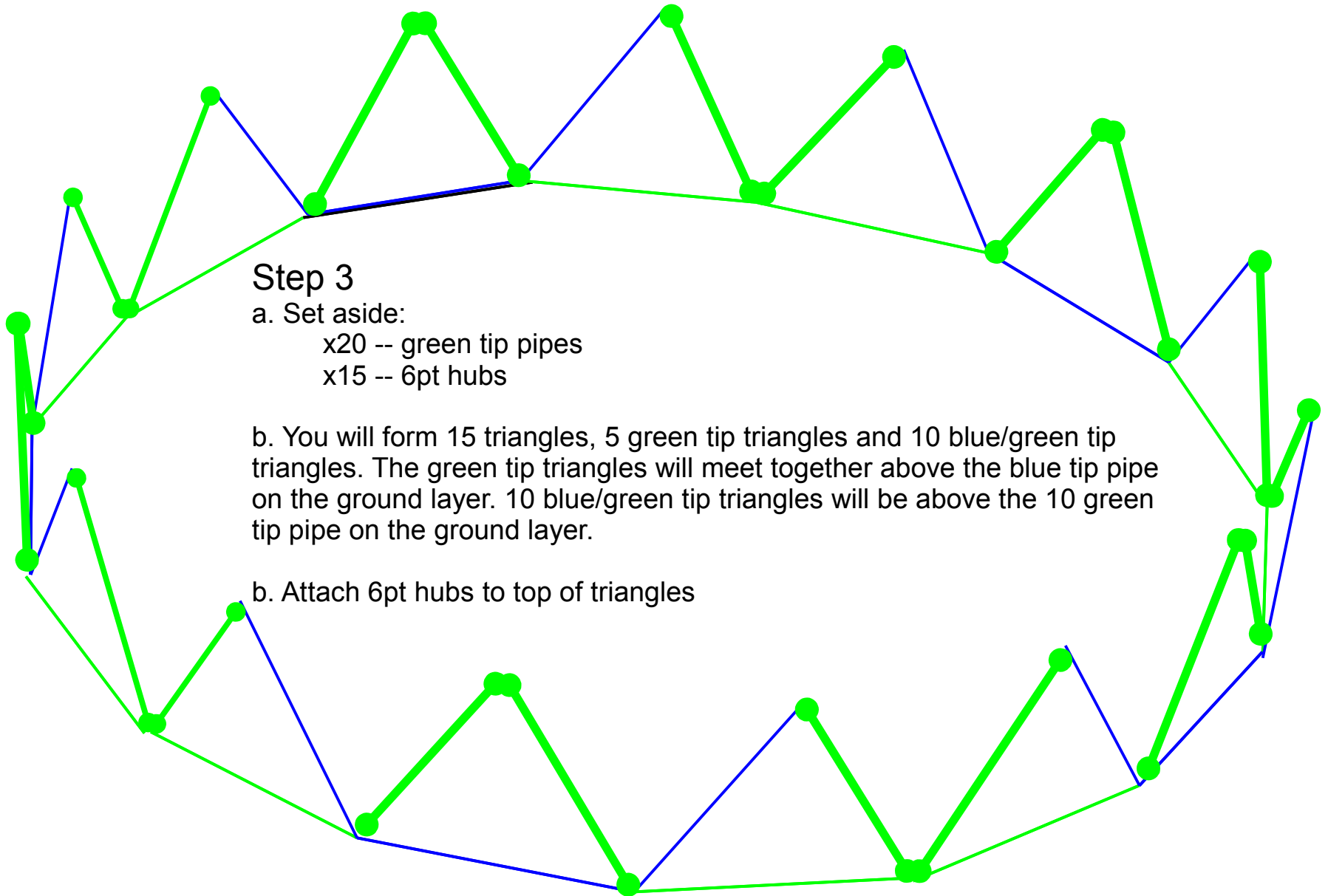

Step 3

a. Set aside:

x20 -- green tip pipes

x15 -- 6pt hubs

b. You will form 15 triangles, 5 green tip triangles and 10 blue/green tip triangles. The green tip triangles will meet together above the blue tip pipe on the ground layer. 10 blue/green tip triangles will be above the 10 green tip pipe on the ground layer.

b. Attach 6pt hubs to top of triangles

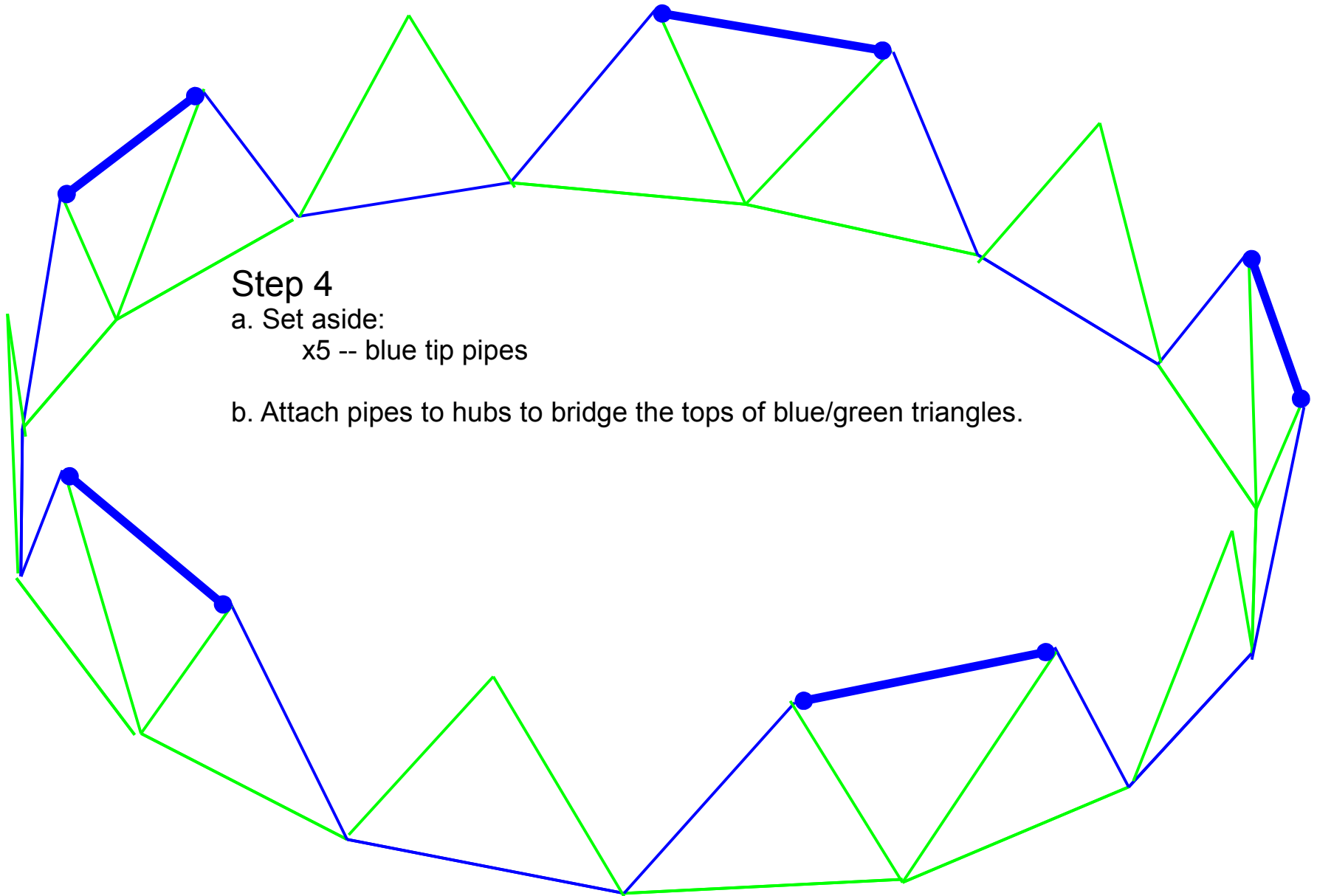

Step 4

a. Set aside:

x5 -- blue tip pipes

b. Attach pipes to hubs to bridge the tops of blue/green triangles.

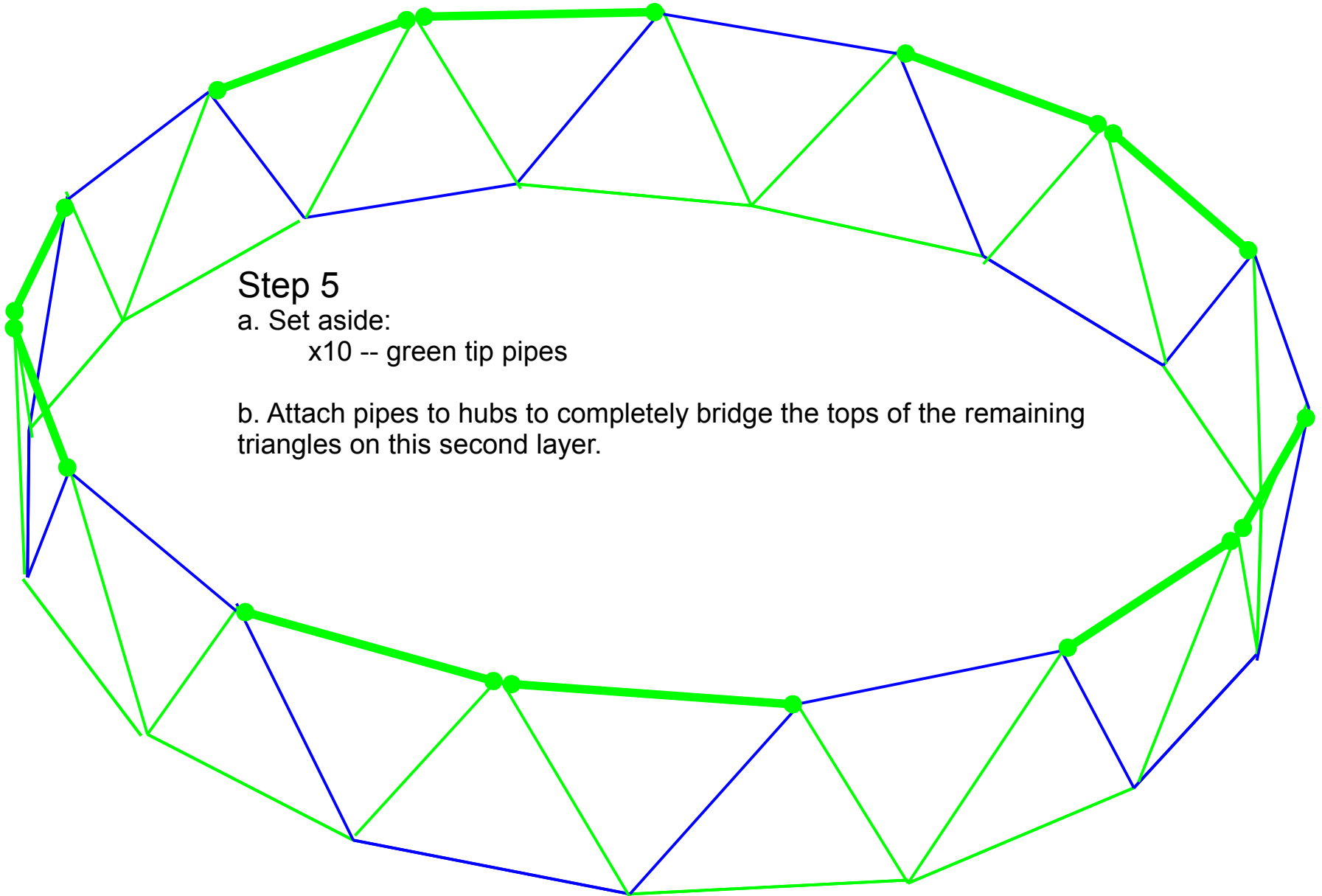

Step 5

a. Set aside:
x10 -- green tip pipes

b. Attach pipes to hubs to completely bridge the tops of the remaining triangles on this second layer.

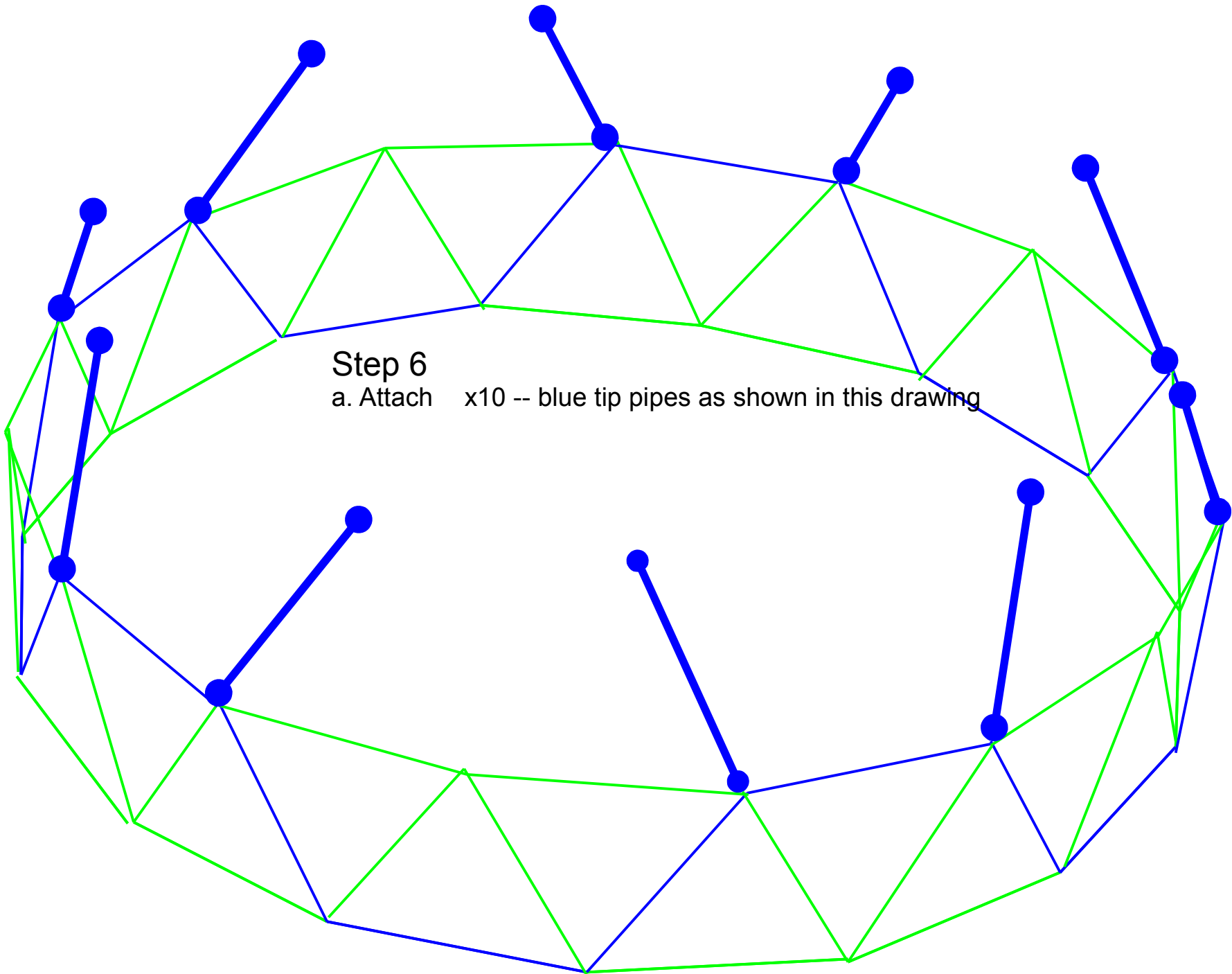

Step 6

a. Attach x10 -- blue tip pipes as shown in this drawing

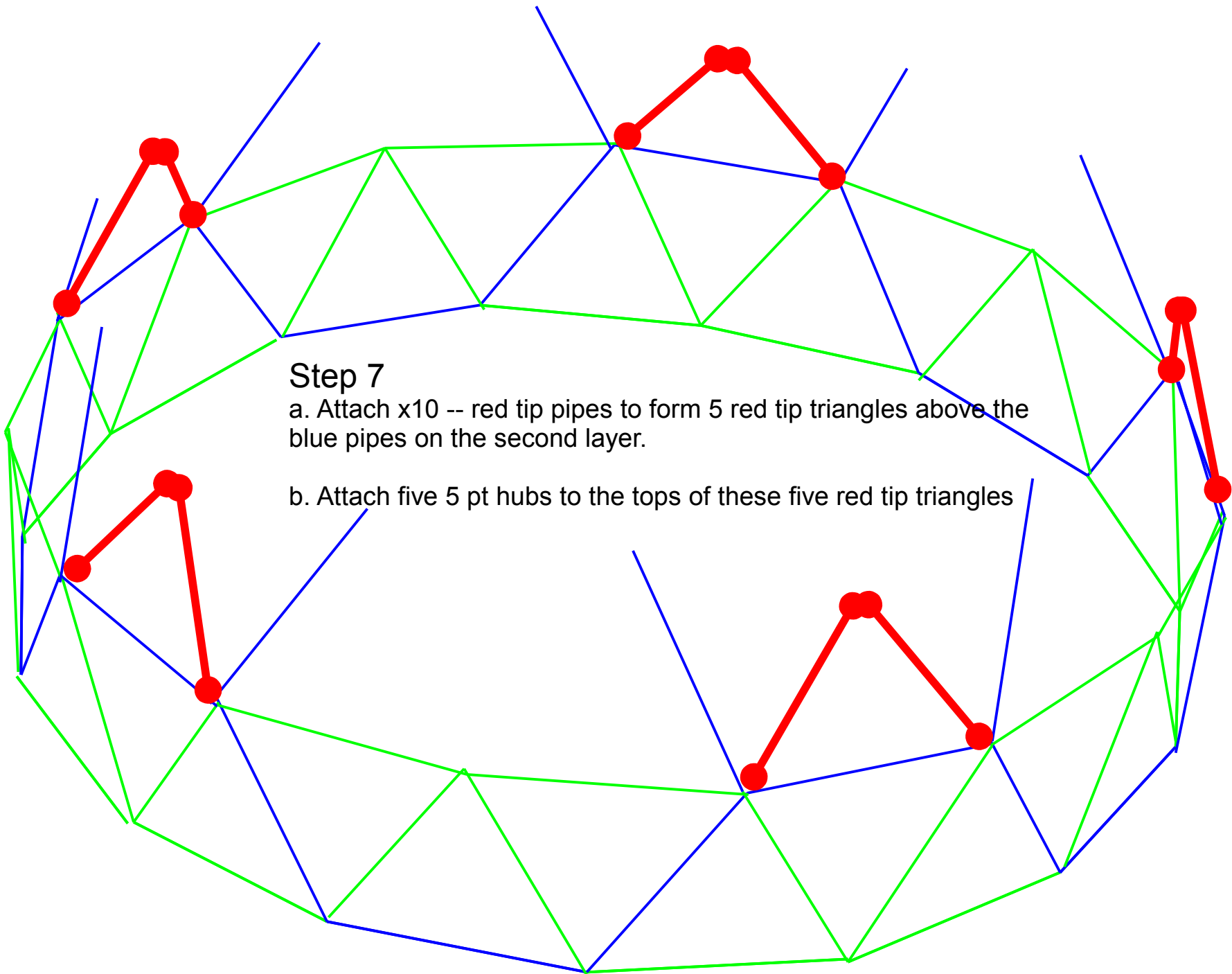

Step 7

a. Attach x10 -- red tip pipes to form 5 red tip triangles above the blue pipes on the second layer.

b. Attach five 5 pt hubs to the tops of these five red tip triangles

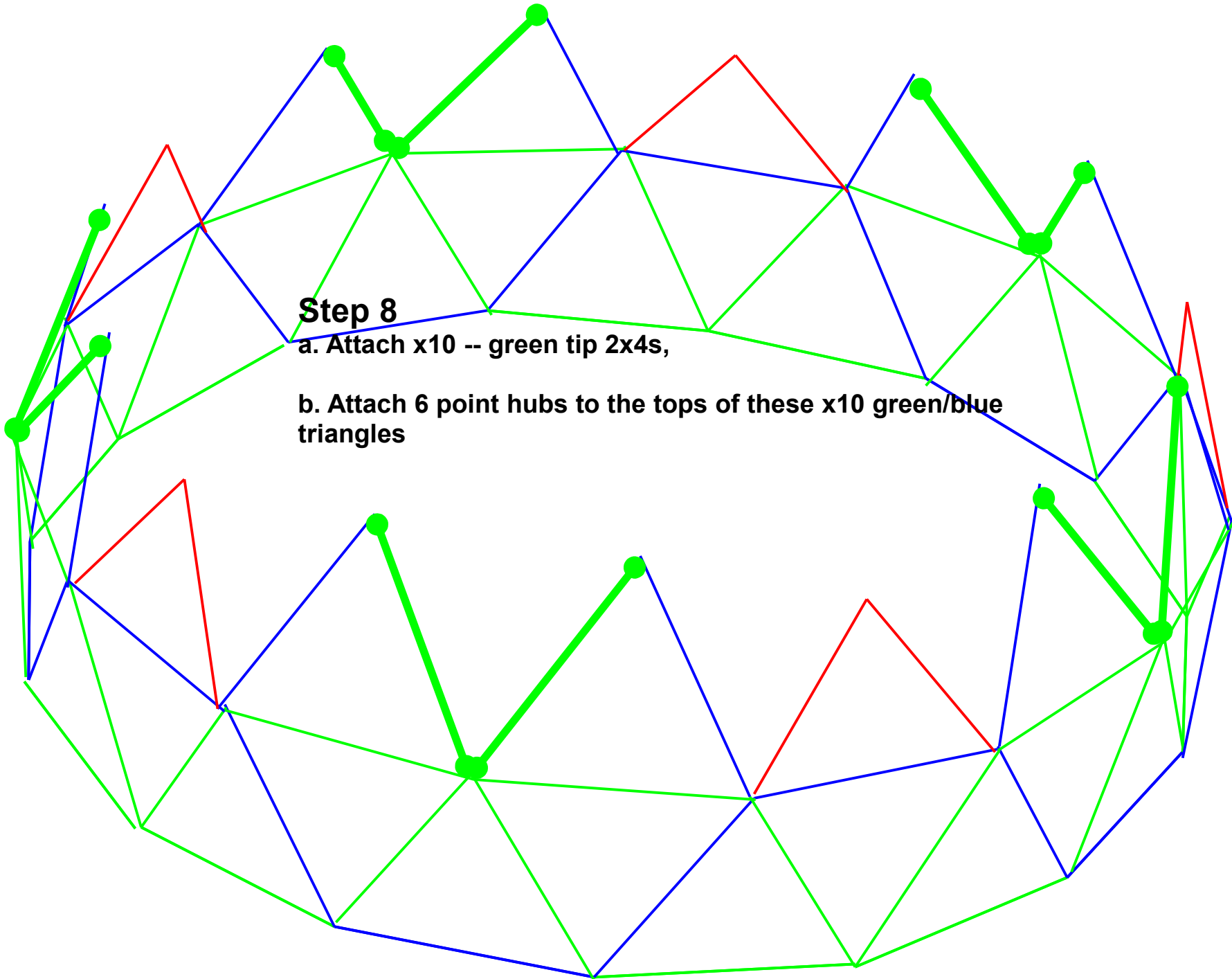

Step 8

a. Attach x10 -- green tip 2x4s,

b. Attach 6 point hubs to the tops of these x10 green/blue triangles

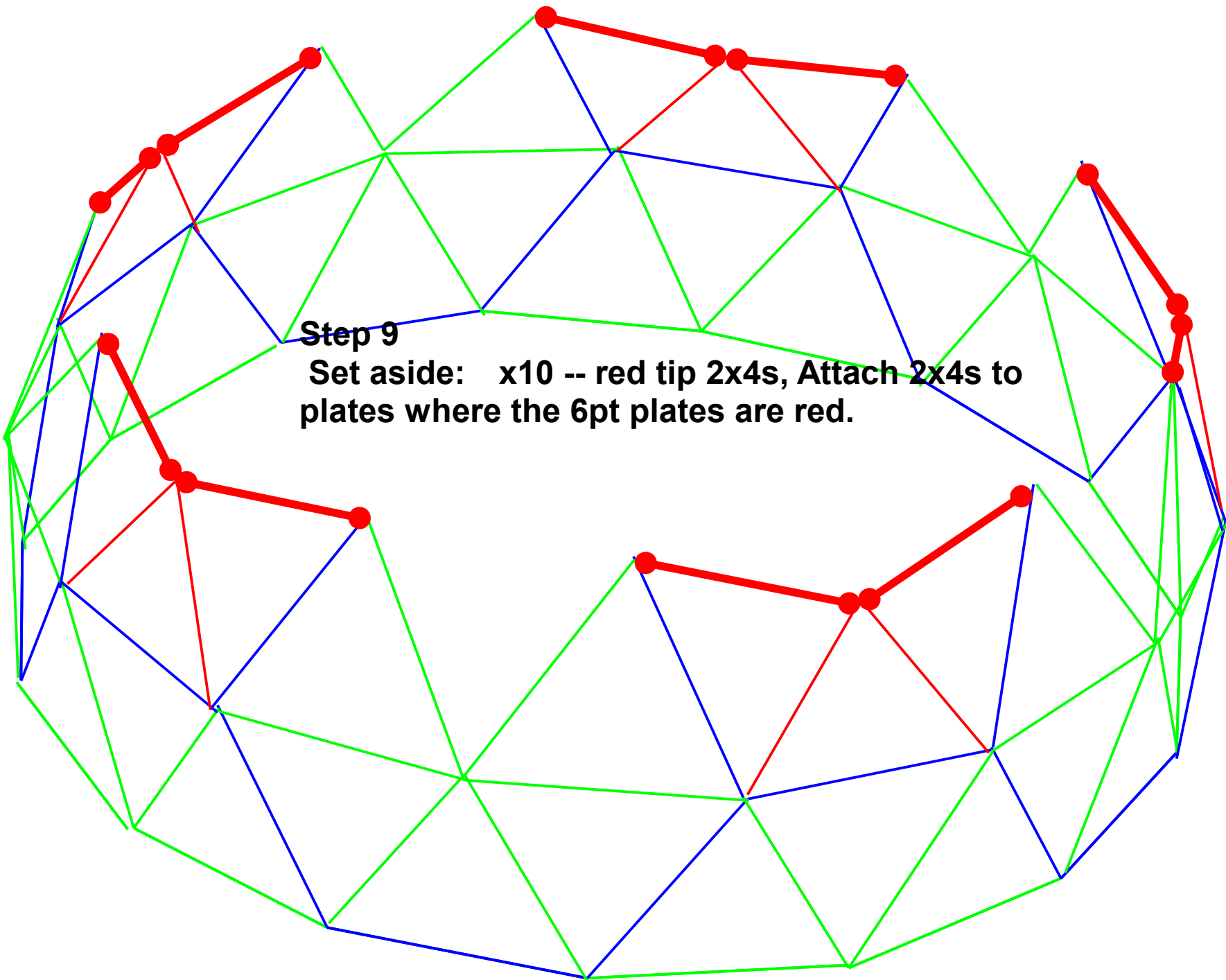

Step 9

Set aside: x10 -- red tip 2x4s, Attach 2x4s to plates where the 6pt plates are red.

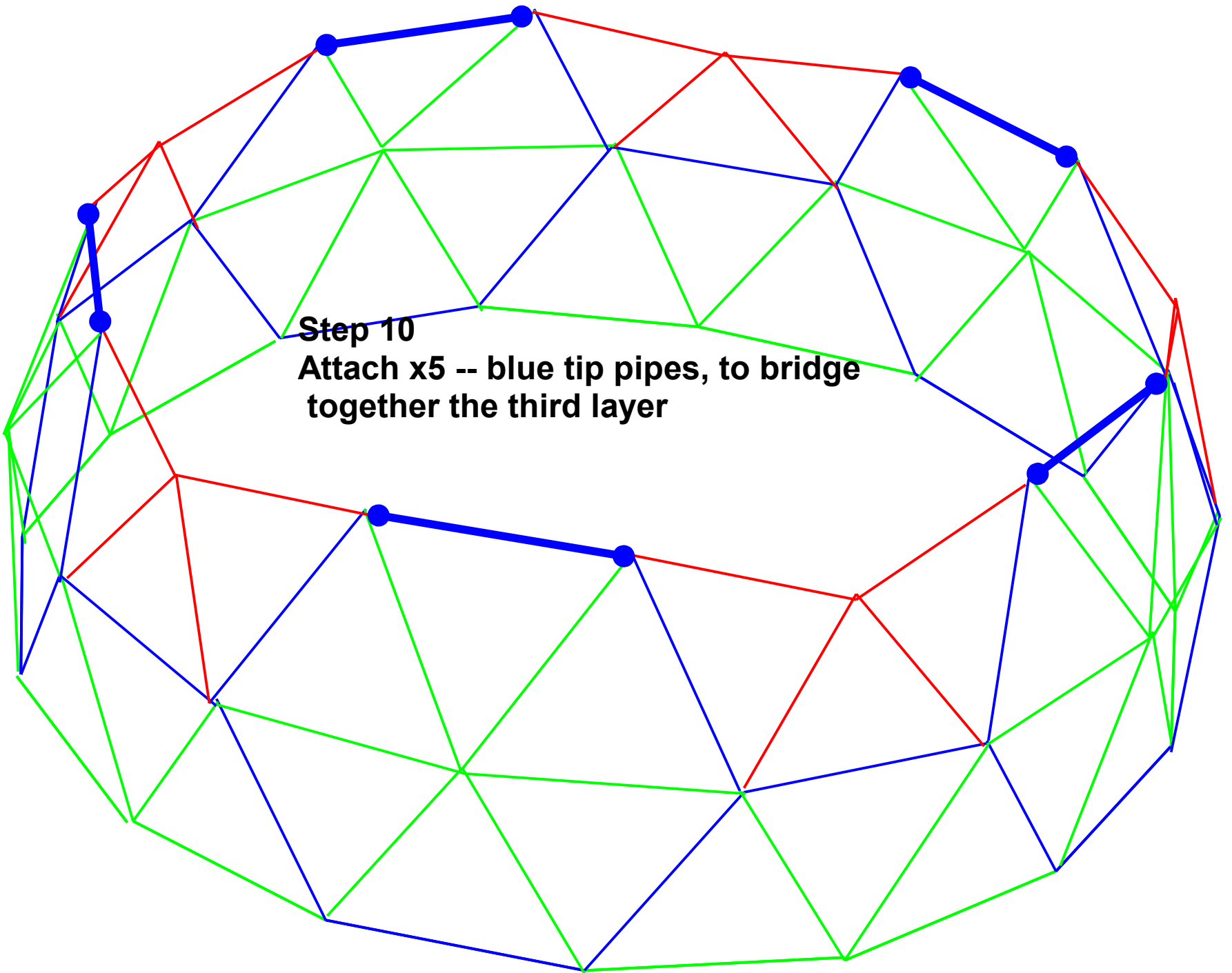

Step 10
Attach x5 -- blue tip pipes, to bridge
together the third layer

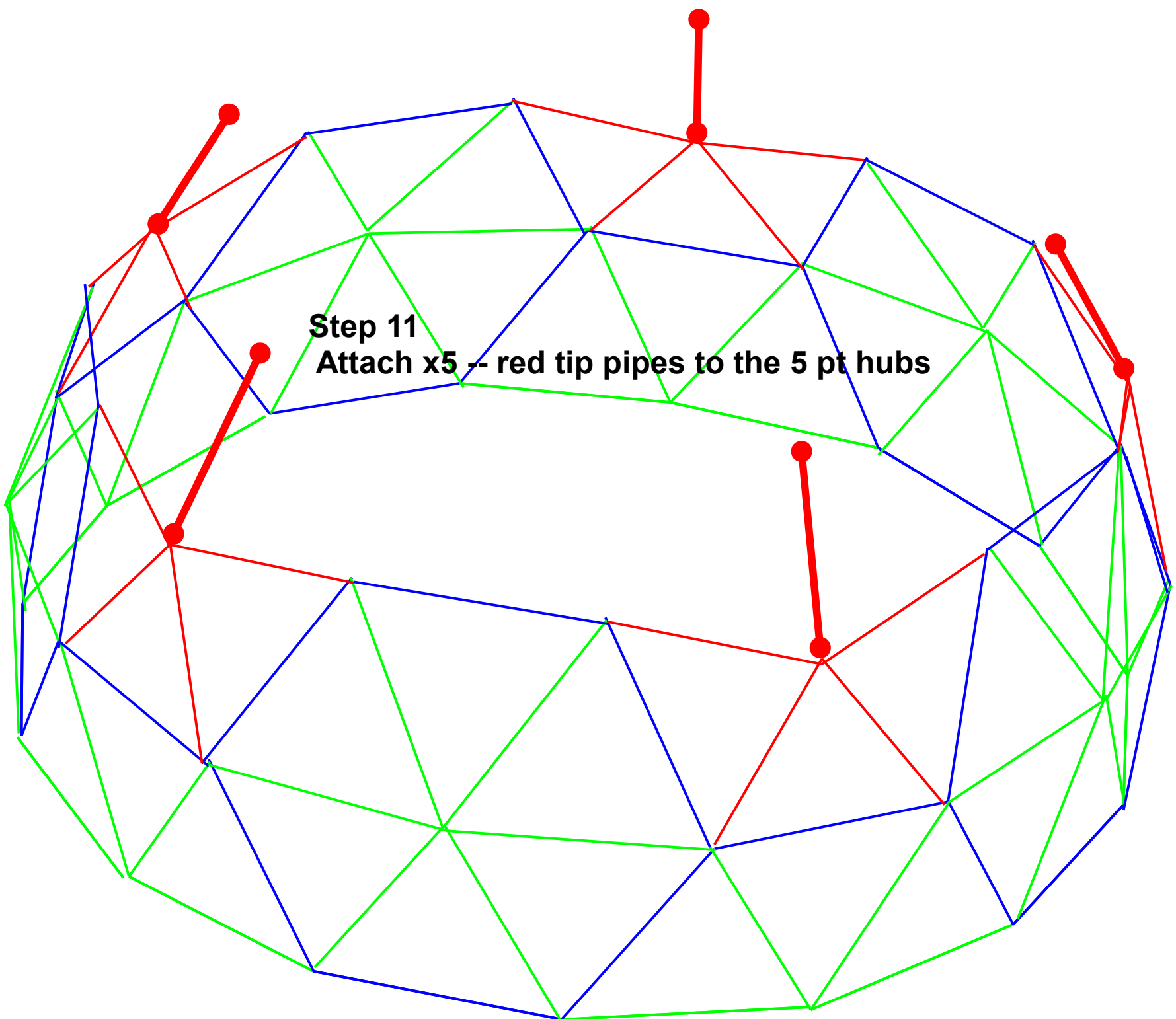

Step 11
Attach x5 -- red tip pipes to the 5 pt hubs

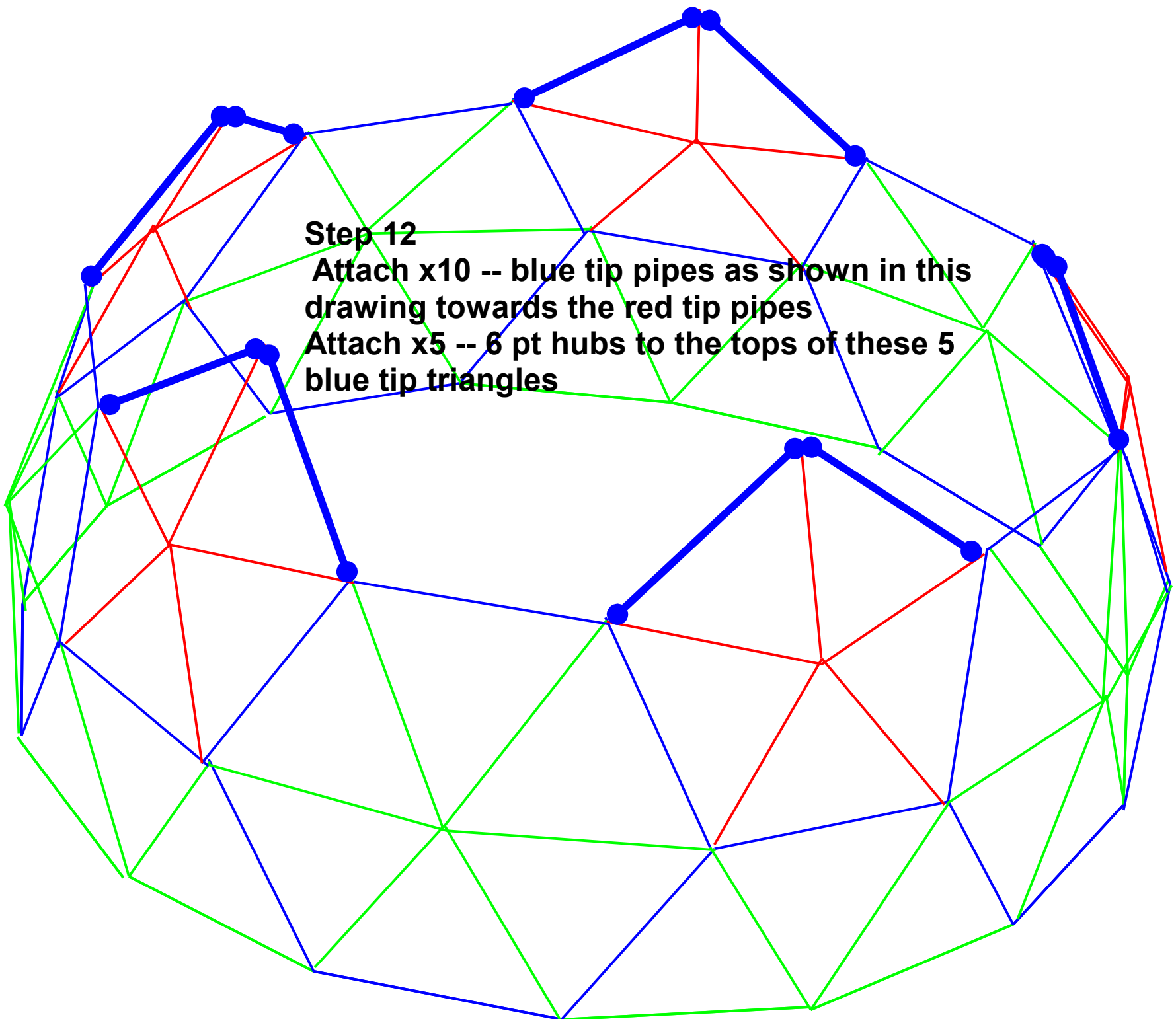

Step 12

Attach x10 -- blue tip pipes as shown in this drawing towards the red tip pipes

Attach x5 -- 6 pt hubs to the tops of these 5 blue tip triangles

Step 13

Attach x10 -- green tip pipes to form 5 green tip triangles

Attach x5 -- 6 pt hubs to the tops of these 5 green triangles

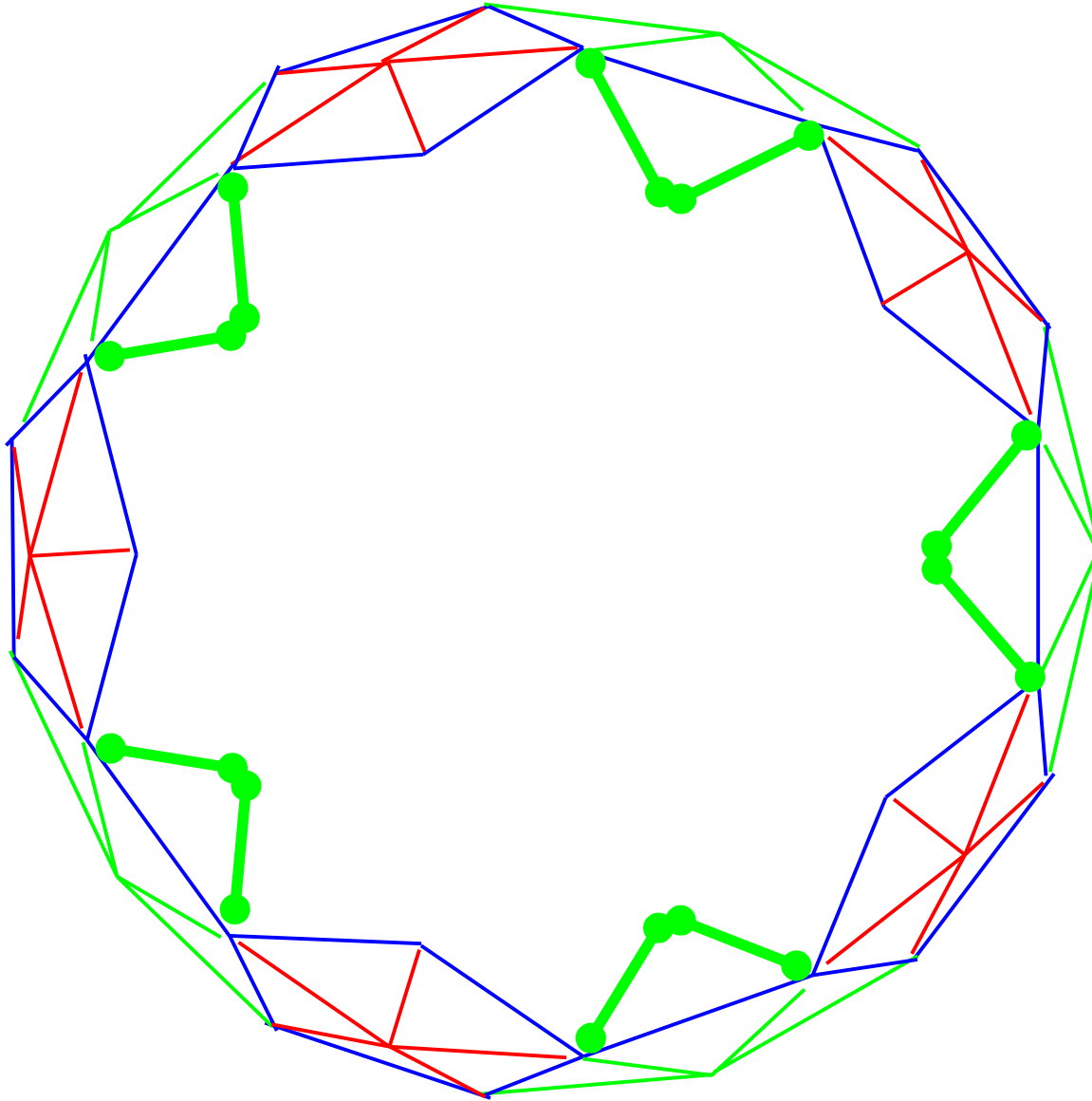

Step 14

Attach x10 -- green tip pipes to bridge together the fourth layer

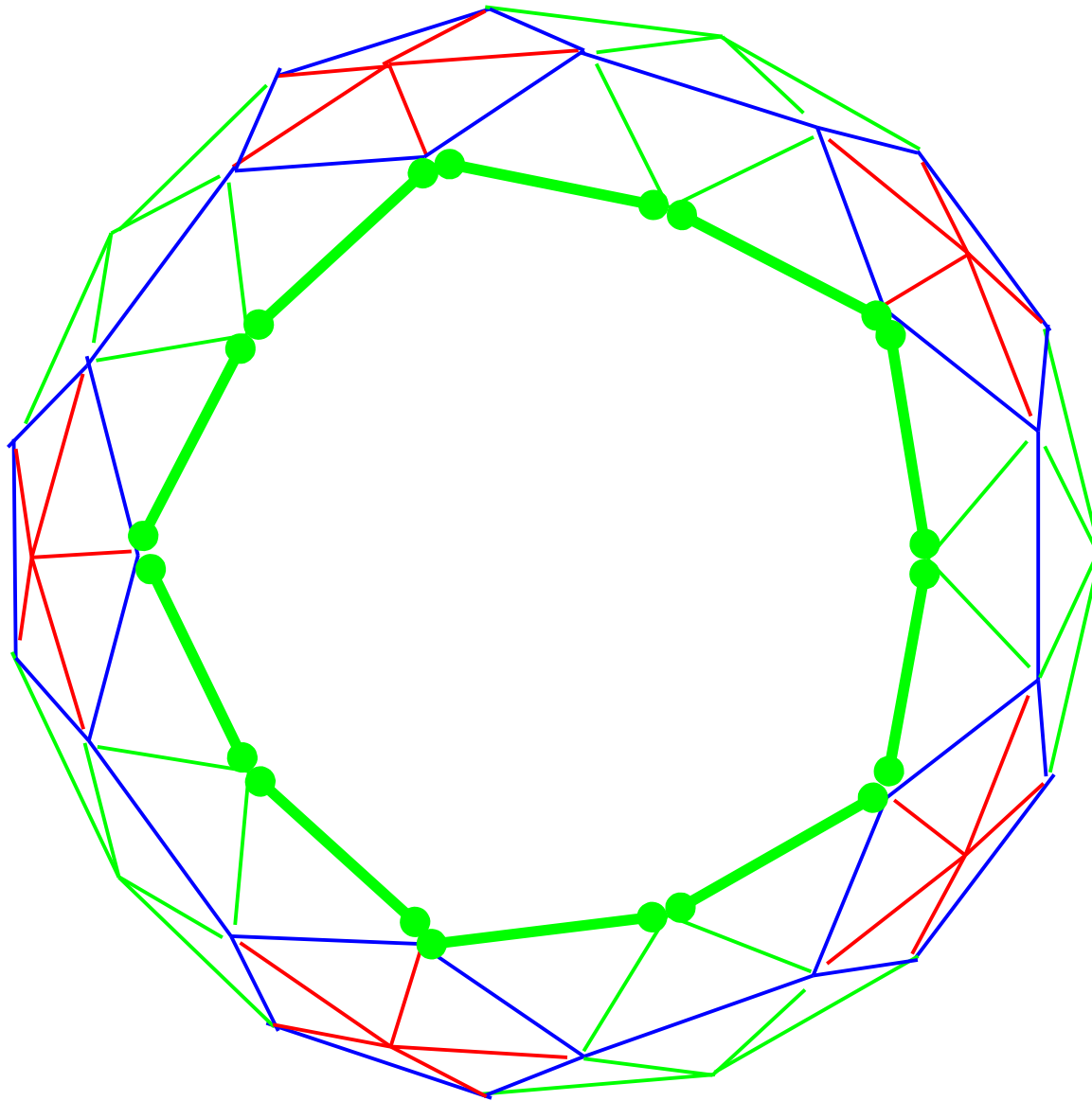

Step 15

attach x5 -- blue tip pipes. They will be parallel with the red pipe in the third layer.

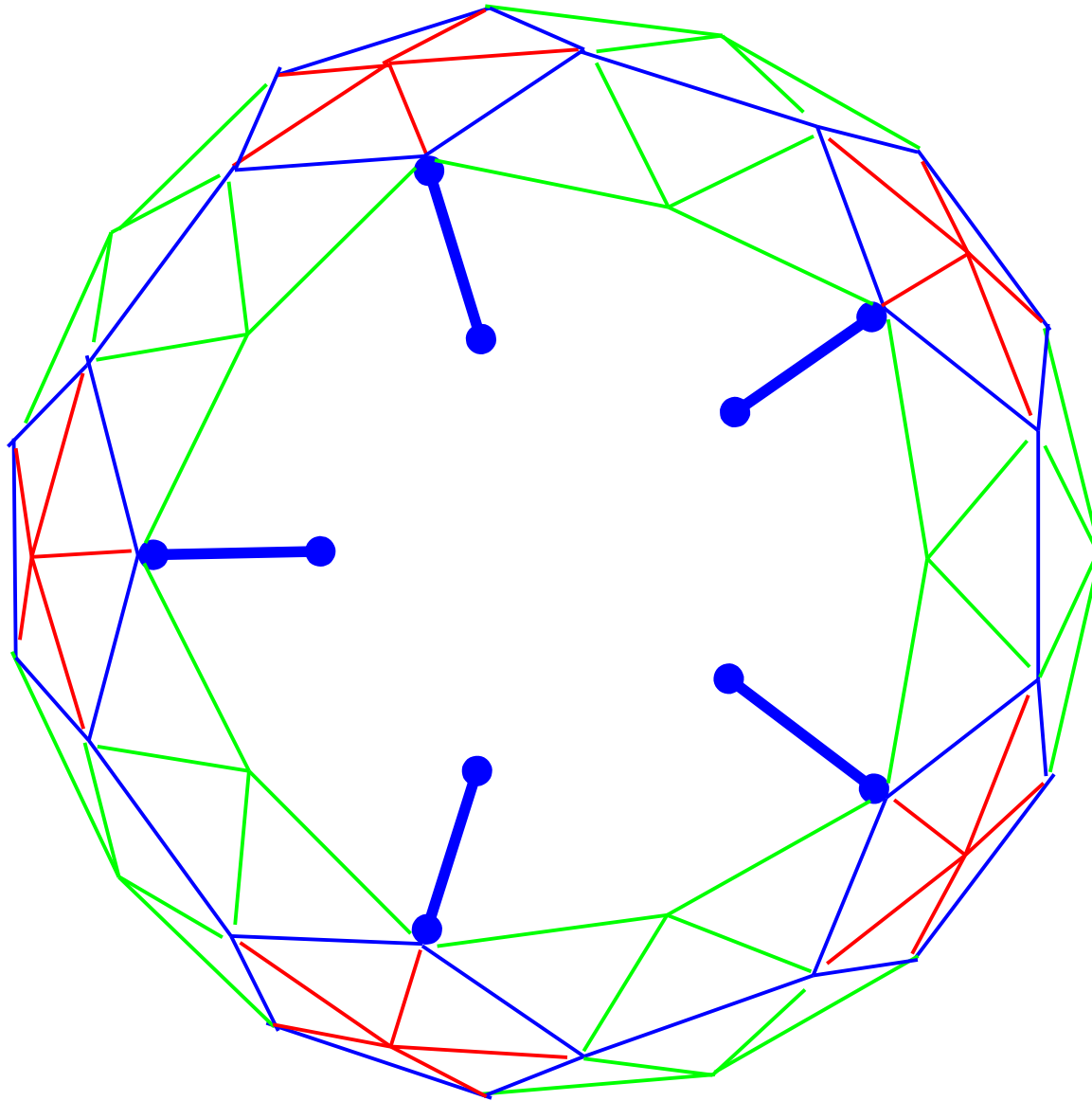

Step 16

attach x10 -- green tip pipes as shown to form five triangles.

Attach x5 -- 6pt hubs to the tops of these triangles.

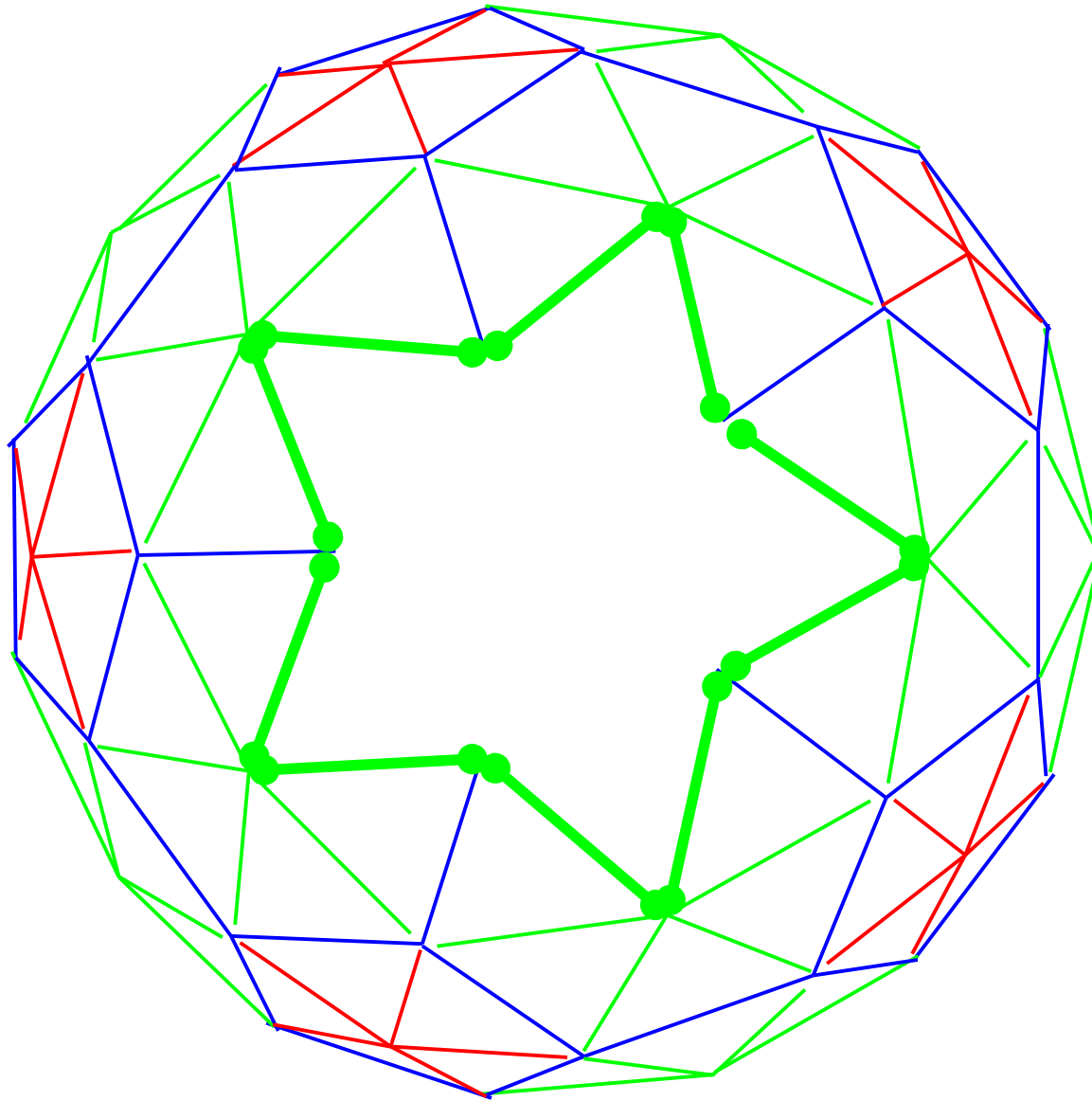

Step 17

Attach x5 -- blue tip pipes to bridge the fifth layer.

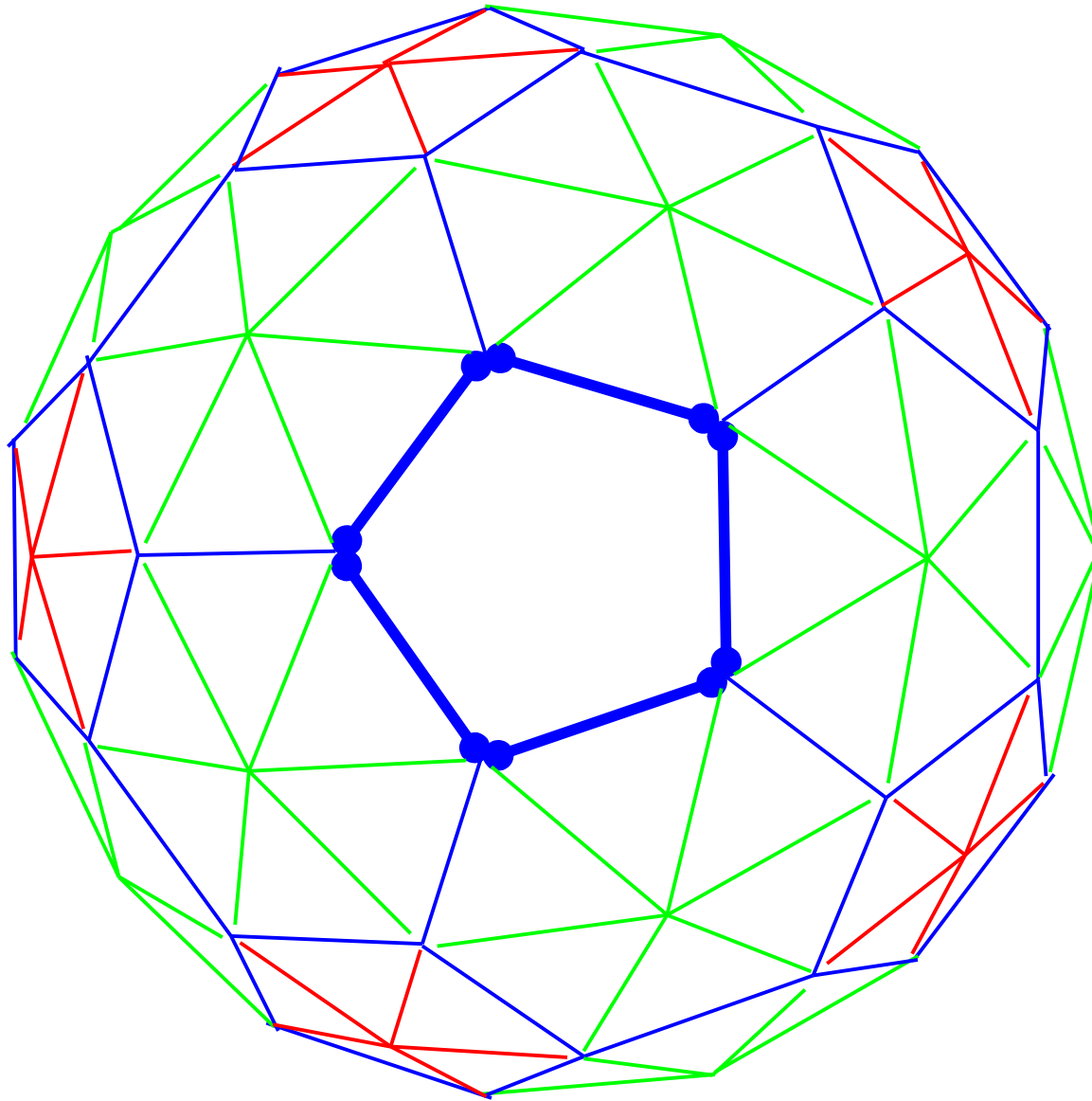

Step 18

attach x5 -- red tip pipes

Attach final 5 pt hub to top of dome

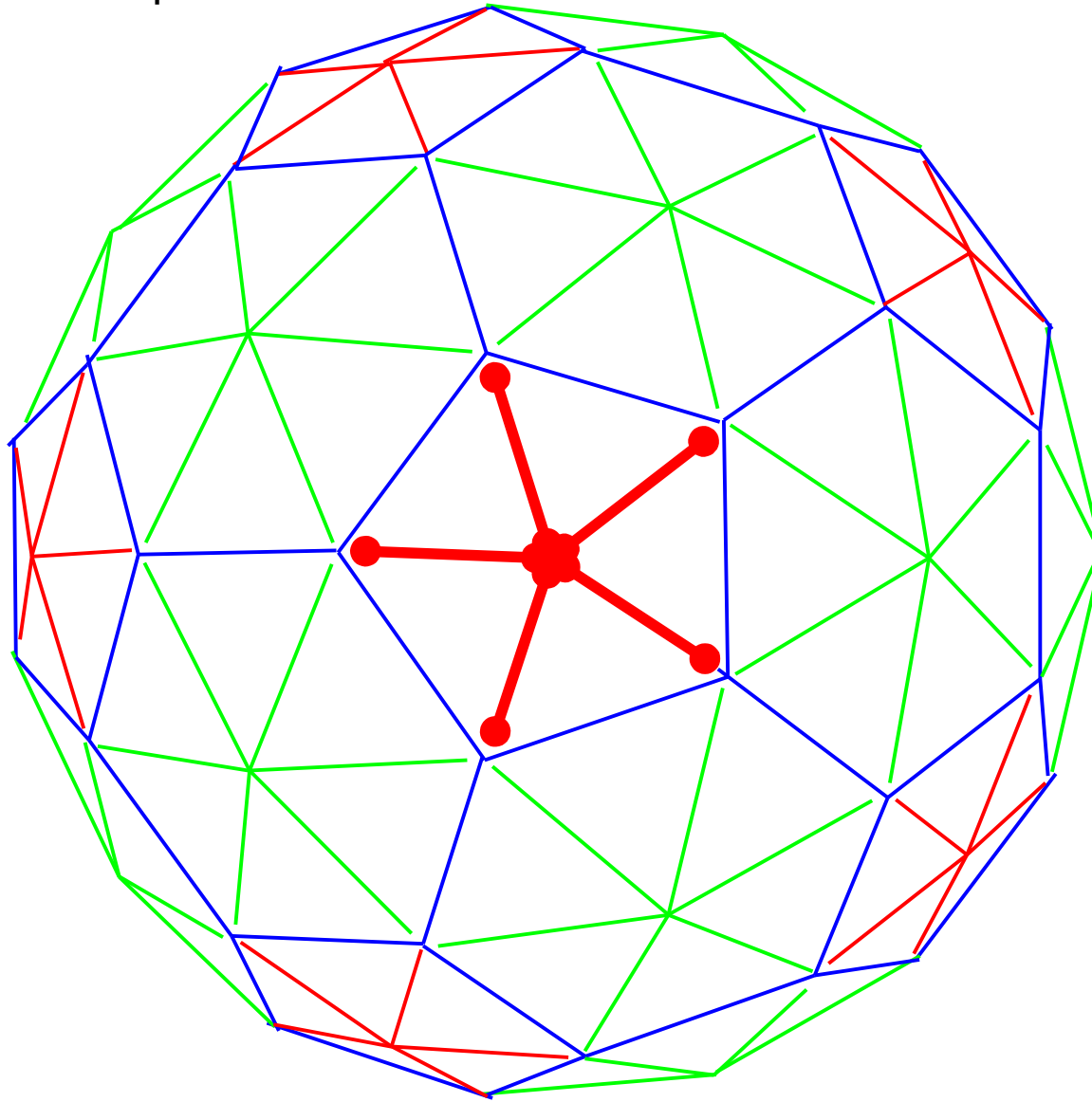

Step 19

Secure all hubs with tension by tightening the nuts starting from the top working around downward. When finished, inspect underneath each hub to ensure the nuts have been tighten.

Suggested Instructions for 5/8ths Dome Cover Using Rigid 4x8 ft Sheets

Given Dome Radius
=116 in. then ...

2x4 cut lengths are:

a'=38 in.

b'=44 in.

c'=45 in.

Panel cover triangle
side lengths are:

A=40.25 in.

B=46.5 in.

C=47.5 in.

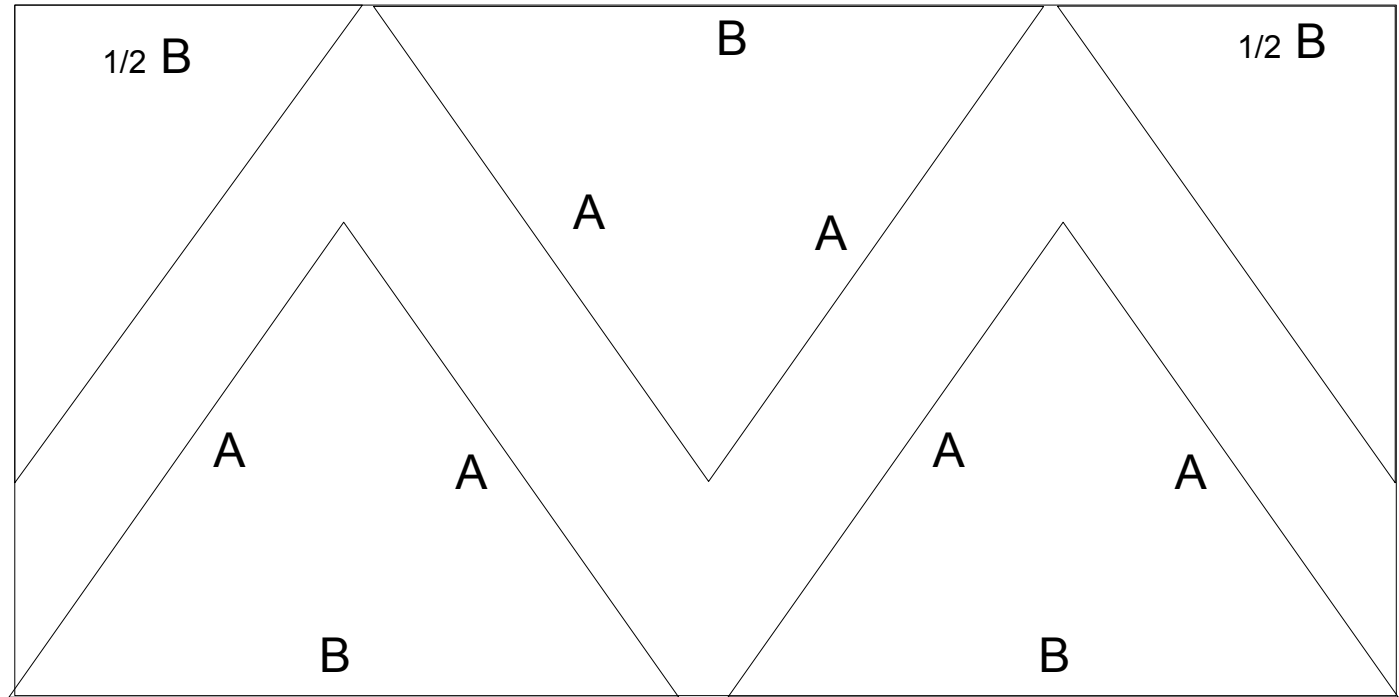

x30 AB triangles required
4 triangles per 4x8ft sheet
so 8 to 10 sheets required
for AB triangles
height AB triangle=32.75 in.
width AB triangle=46.5 in.

75 BC triangles required
4 triangles per 4x8ft sheet
so 19 to 25 sheets required
for BC triangles
height of BC triangle=41.42 in.
width of BC triangle=46.5 in.

**x27 to x35 sheets
required for cover**

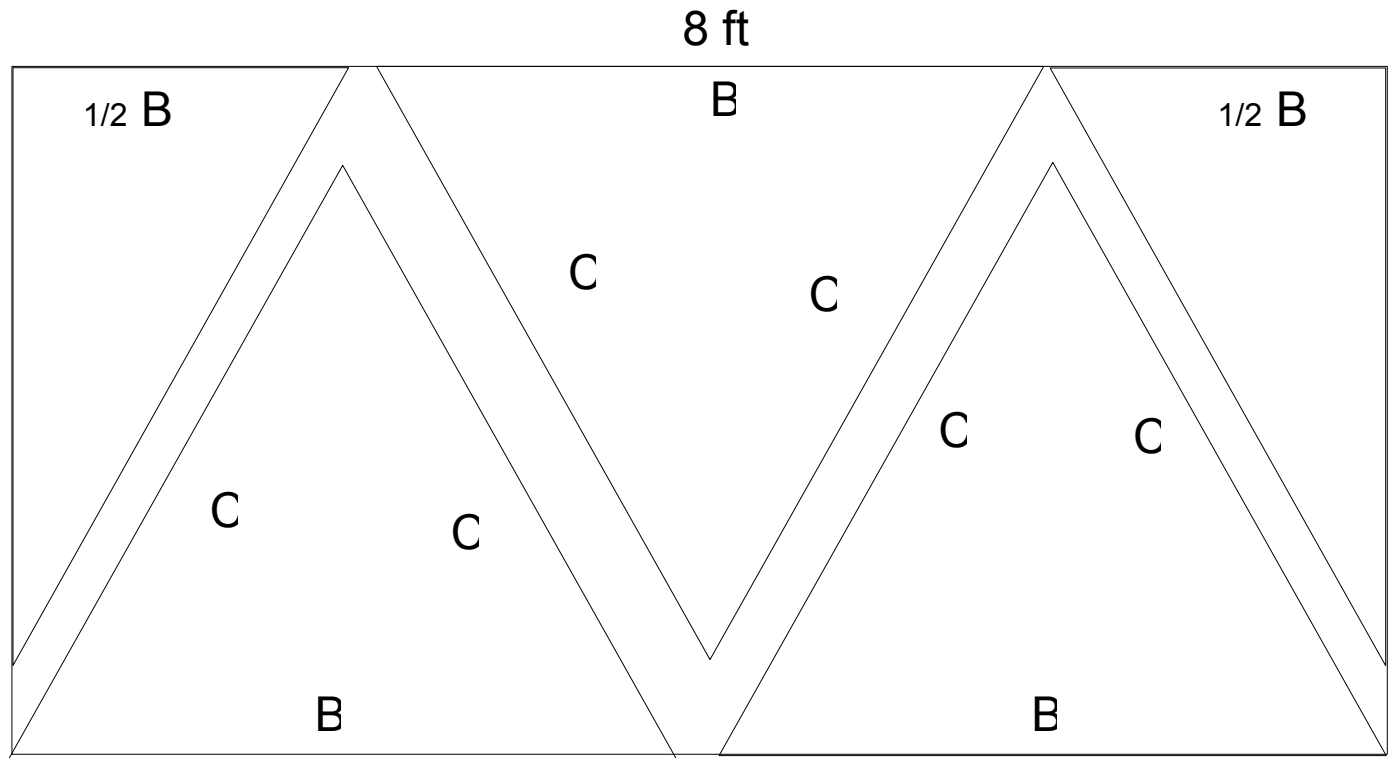

Suggested Instructions for 5/8ths Dome Cover Using Thin Plastic or Canvas/Cloth Sheeting

Given Dome Radius
=116 in. then ...

2x4 cut lengths are:

$a'=38$ in.

$b'=44$ in.

$c'=45$ in.

Panel cover triangle
side lengths are:

A=40.25 in.

B=46.5 in.

C=47.5 in.

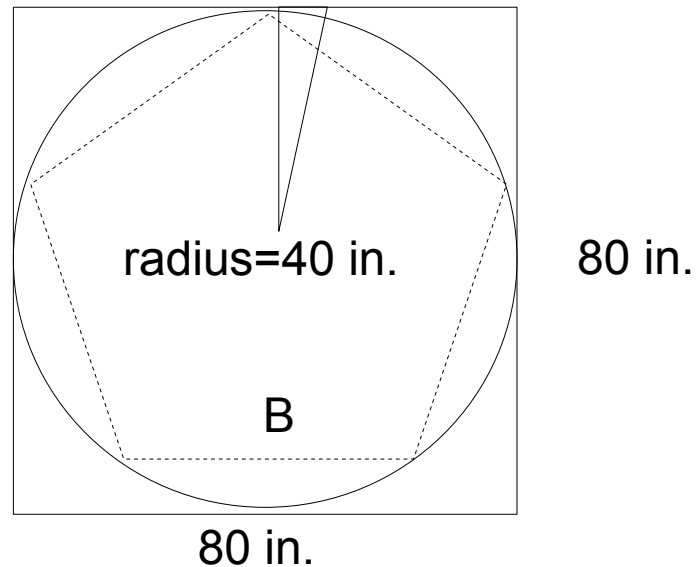

Draw circles on sheeting to be cutout using
string measure as radius with center point
tack nail and pen on the other end.

x6 pentagon circle cutouts
40 inch radius

x10 hexagon circle cutouts
47 inch radius

x5 half hexagon cutouts
47 inch radius .. half

