

4x9ft Dome Climber -- 3 Frequency 3/8 Dome Assembly Instructions

Inventory

- **46 Hub Units Total**

x25 Hexagon hubs (6 point)

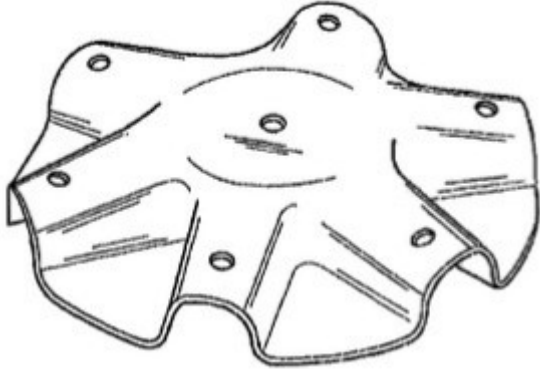

x6 Pentagon Hubs (5 point)

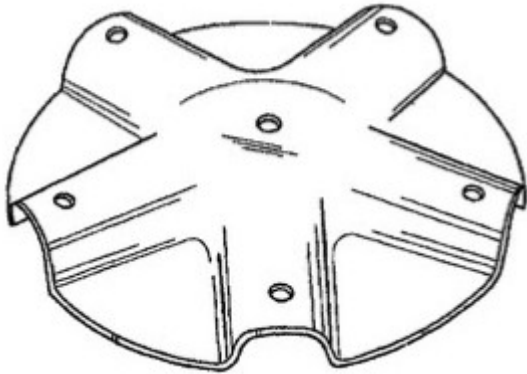

15 Quad hubs (4 point)

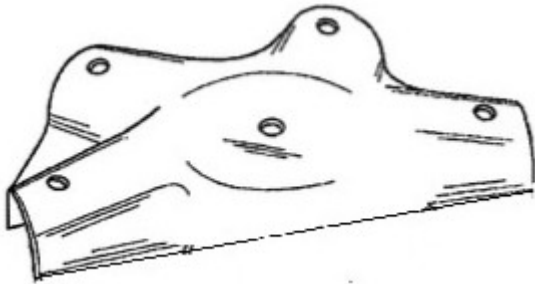

- **120 PVC Pipes**

x50 Green tip  

x40 Blue tip  

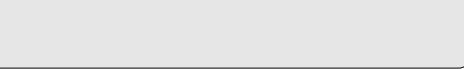
x30 Red tip  

- **240 Nuts and Bolts**

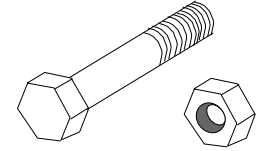

Quick Overview of Hub Unit Assembly Procedure

Its a 2 phase process. The first phase you will just get everything assembled loosely in place with a bolt and nut attaching the pipe to the hub. The second phase after all the segments are in place is where the segments are locked into place by tightening the nuts with a cordless drill or wrench with 7/16" socket.

The pipes have writing on one side, Attach the pipes to dome so the writing is facing towards the center inside of the dome. That way, from outside the dome the writing will not be visible.

What else you will need:

- Cordless drill or wrench with 7/16" socket or equivalent that will tightens 1/4" nuts
- 4 to 5 hours Assembly Time
- Recommended rubber coated knit gloves and safety glasses.

Hub Assembly Overview

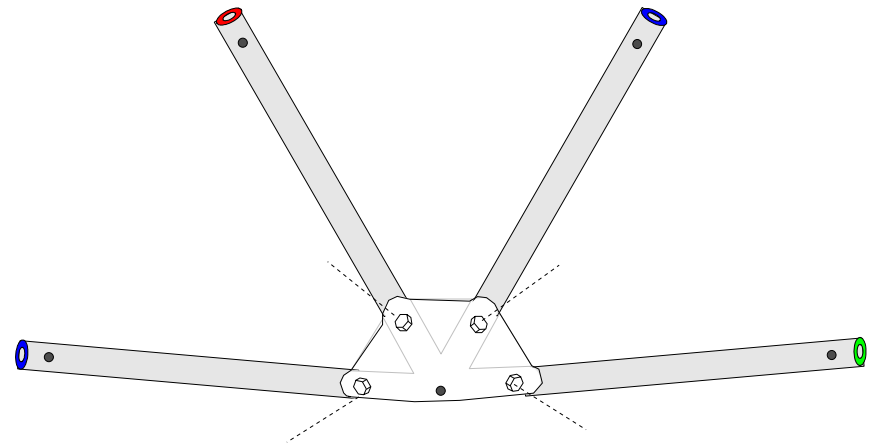
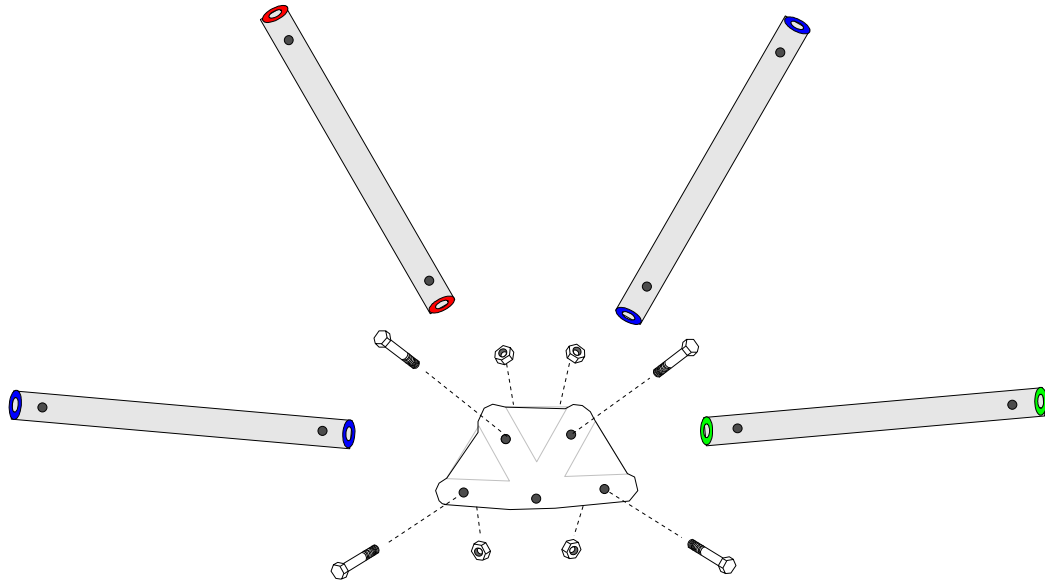

Step 1

a. Set aside:

x15 -- 4pt hubs

x5 -- blue tip pipes

x10 -- green tip pipes

c. Assemble the hub connections. Attach pipe to hub with bolt and nut just hand tighten the nut onto each bolt.

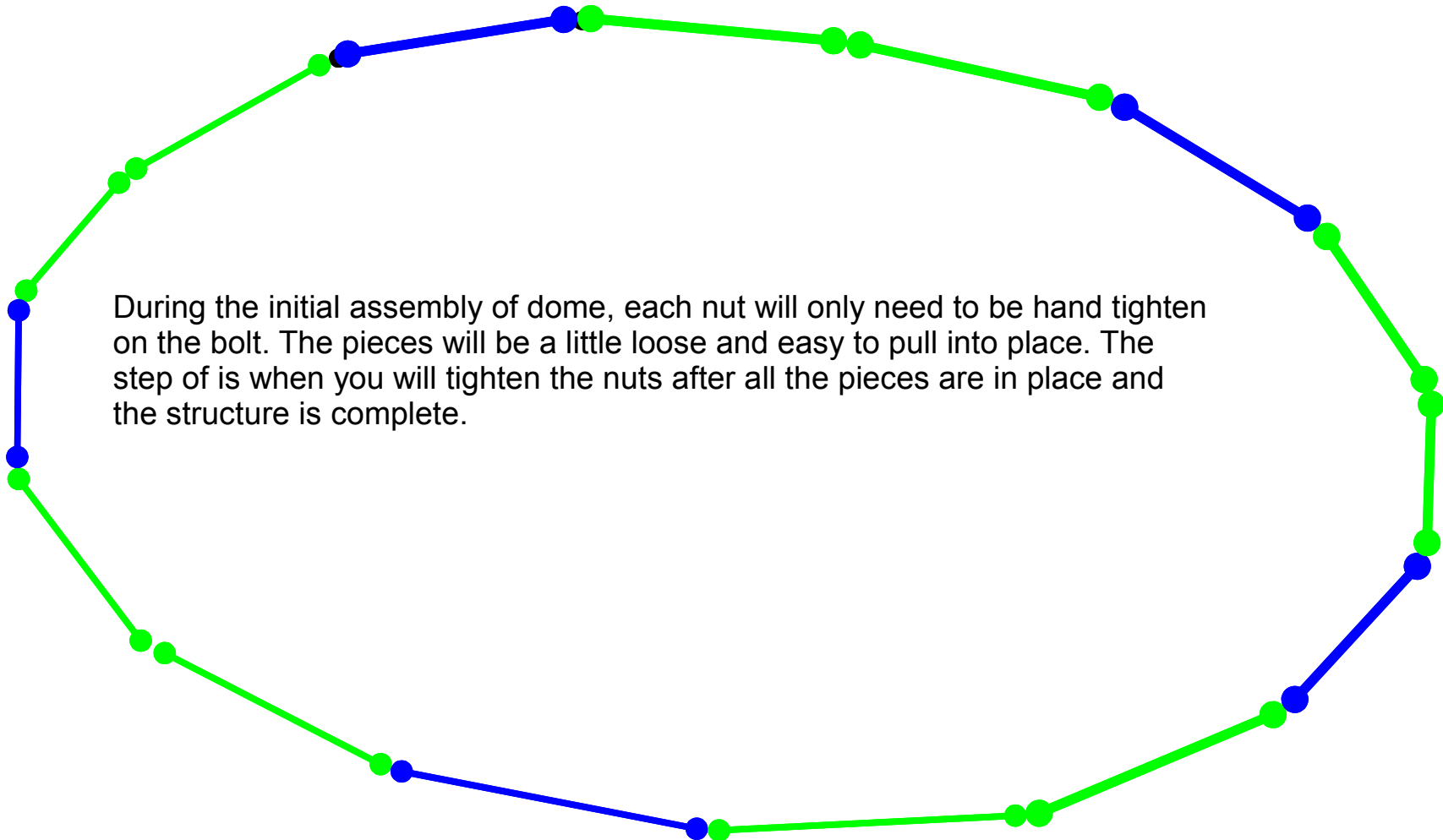

Step 2

a. Attach x10 -- red tip pipes to form 5 red tip triangles above the blue pipes on the second layer.

b. Attach five 5 pt hubs to the tops of these five red tip triangles

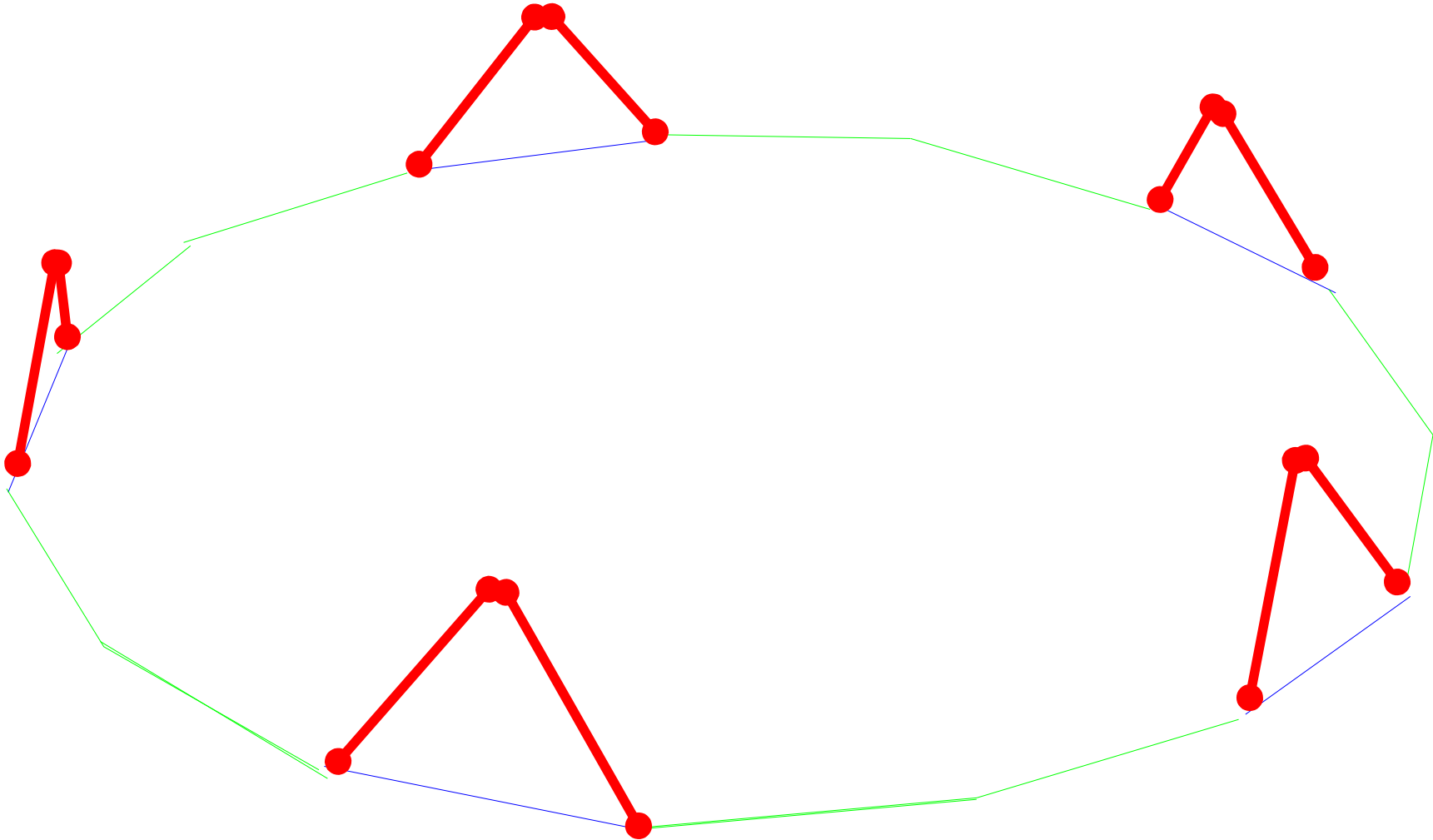

Step 3

a. Set aside:

x10 -- blue tip pipes

b. Attach pipes to tops of 4 pt hubs next the red tip triangles

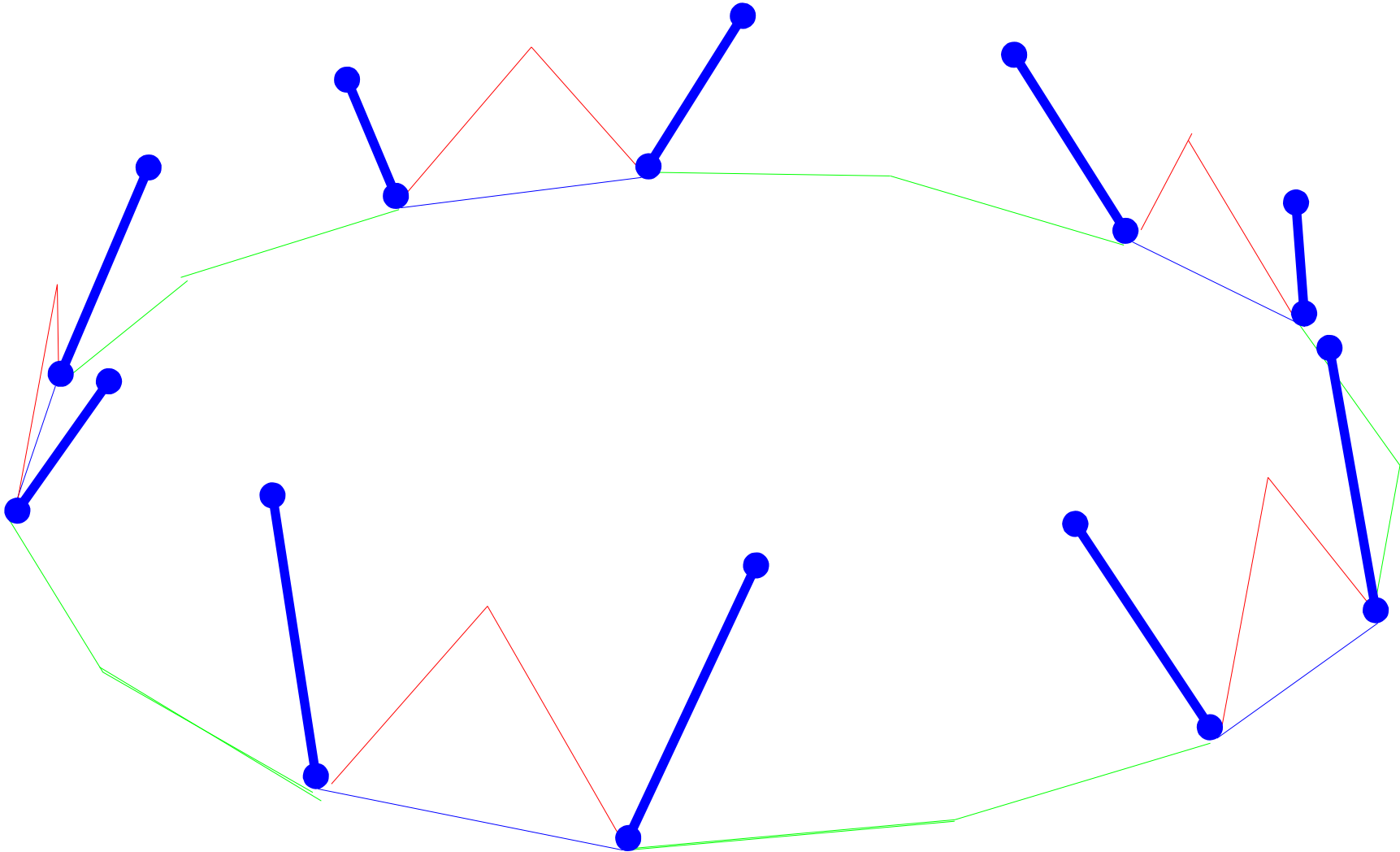

Step 4

a. Attach x10 -- green tip pipes to other remaining 4 pt hubs

b. Attach 6 point hubs to the tops of these x10 green/blue triangles

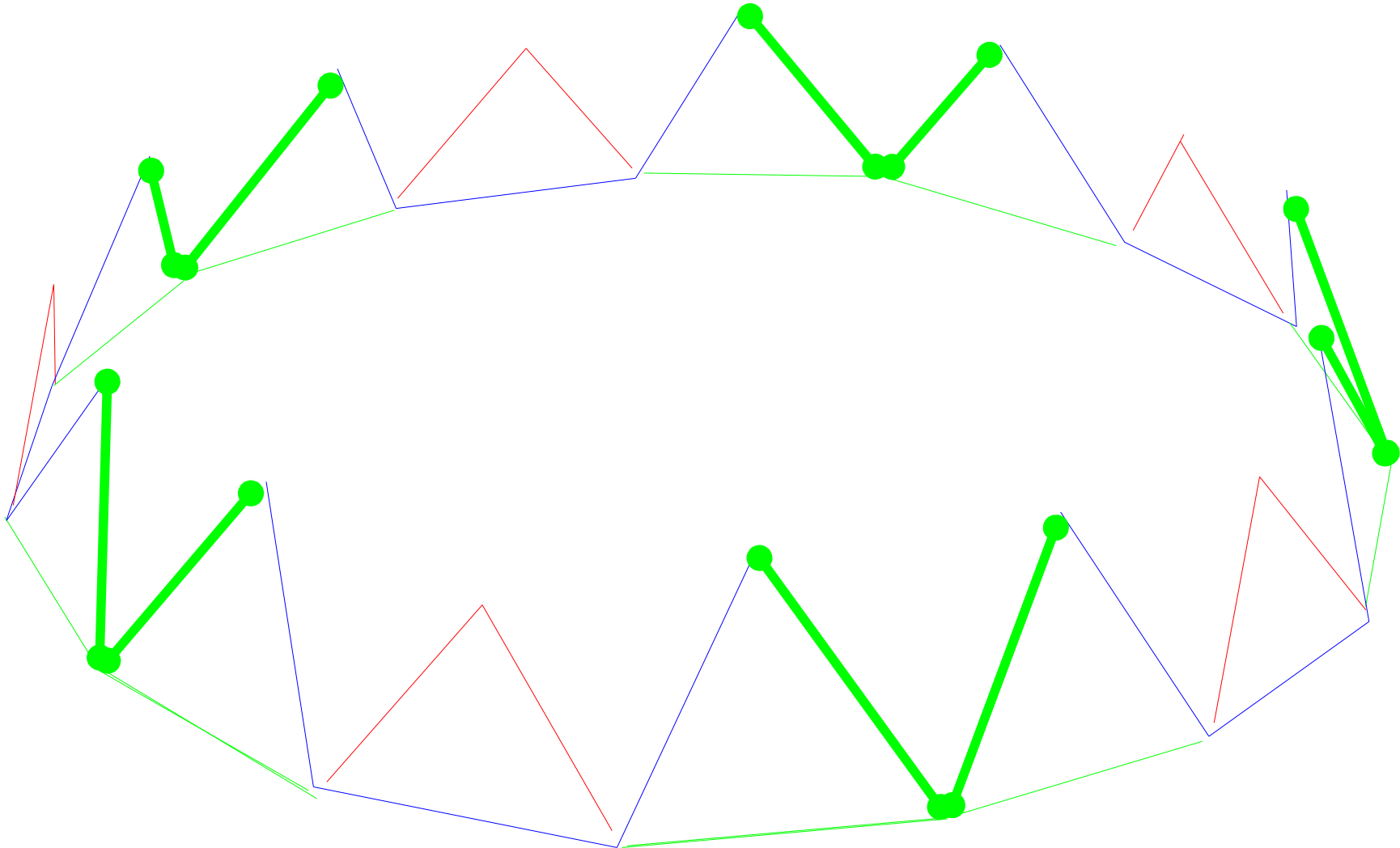

Step 5

Set aside: x10 -- red tip pipes, Attach red tip pipes to bridge the 6pt hubs to the 5pt hubs.

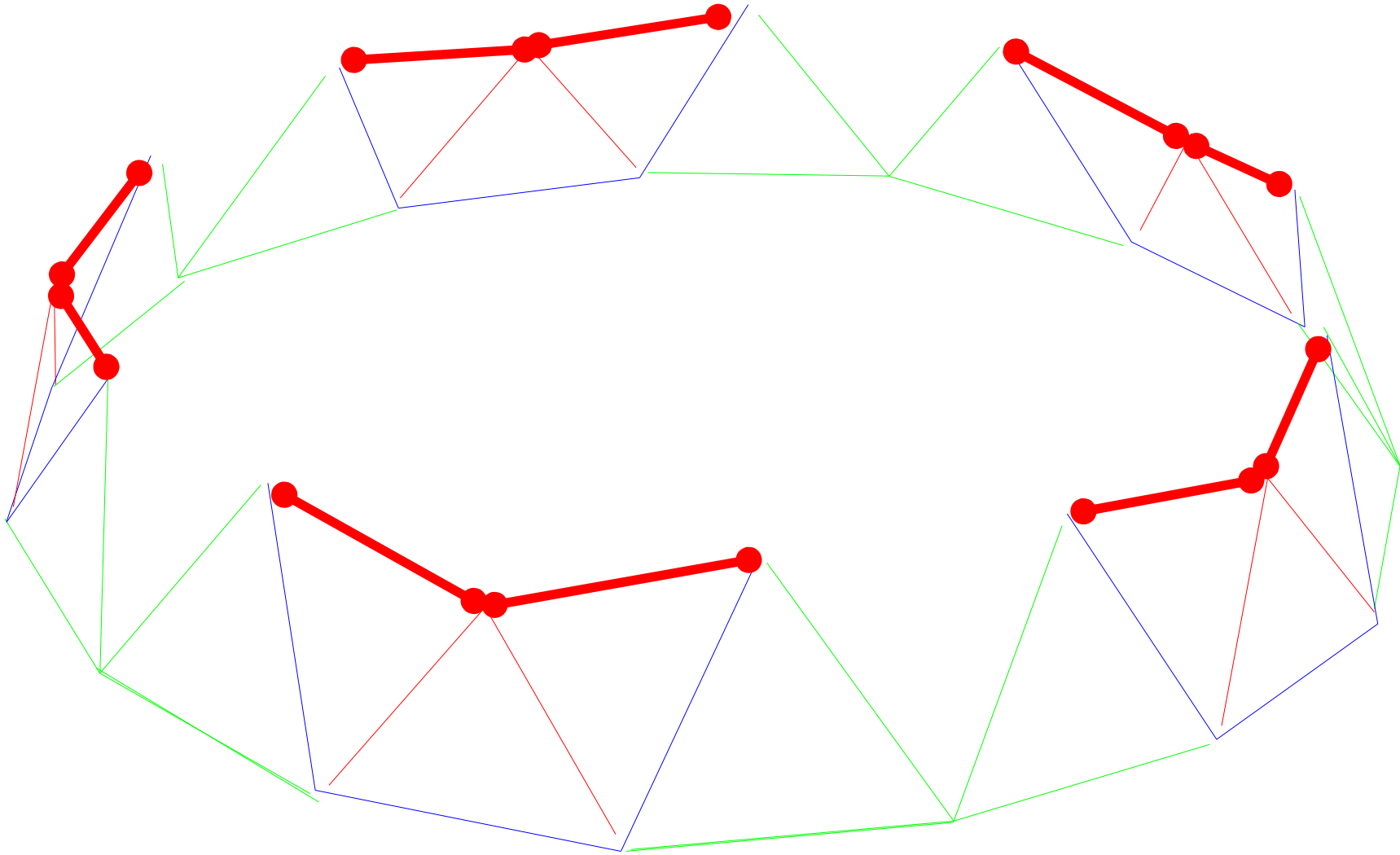

Step 6

Set aside: x5 -- blue tip pipes, Attach pipes to 6pt hubs to bridge together the third layer

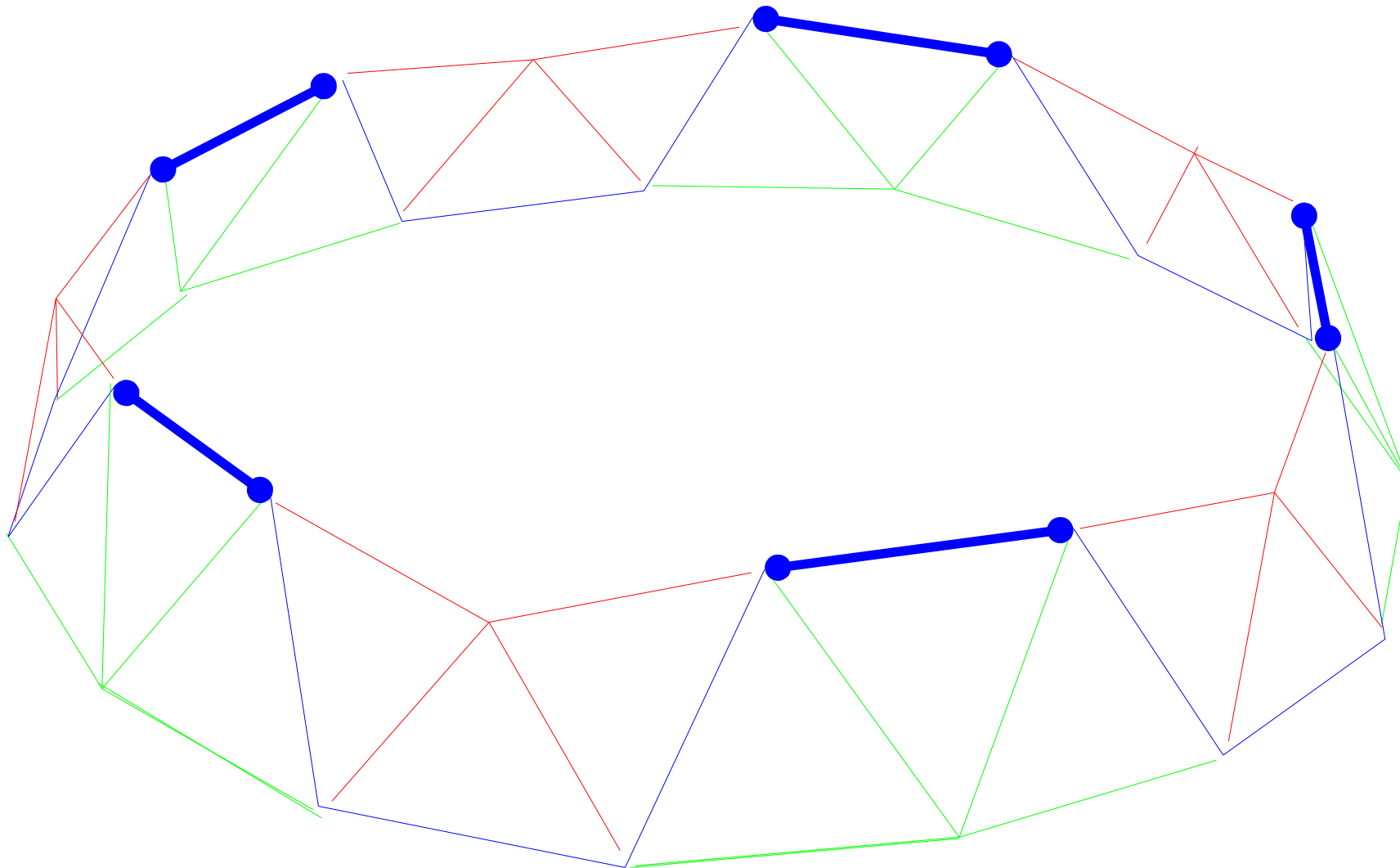

Step 7
Set aside: x5 -- red tip pipes -- Attach pipes to 5pt hubs so the pipes will be pointing upwards

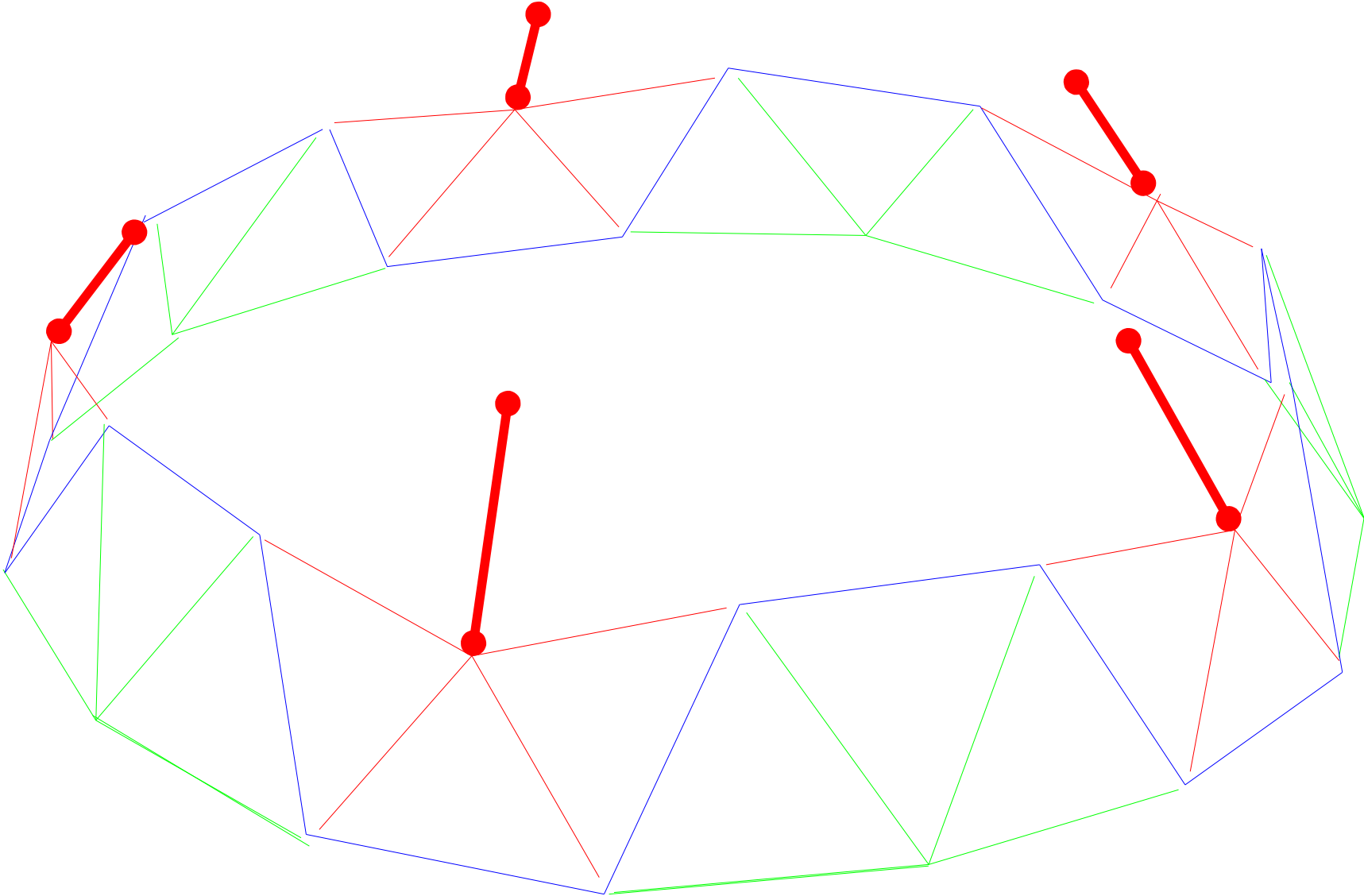

Step 8
Attach x10 blue tip pipes as shown in this
drawing so they are pointing towards the red tip pipe
Attach 6 pt hubs to the tops of these pentagons

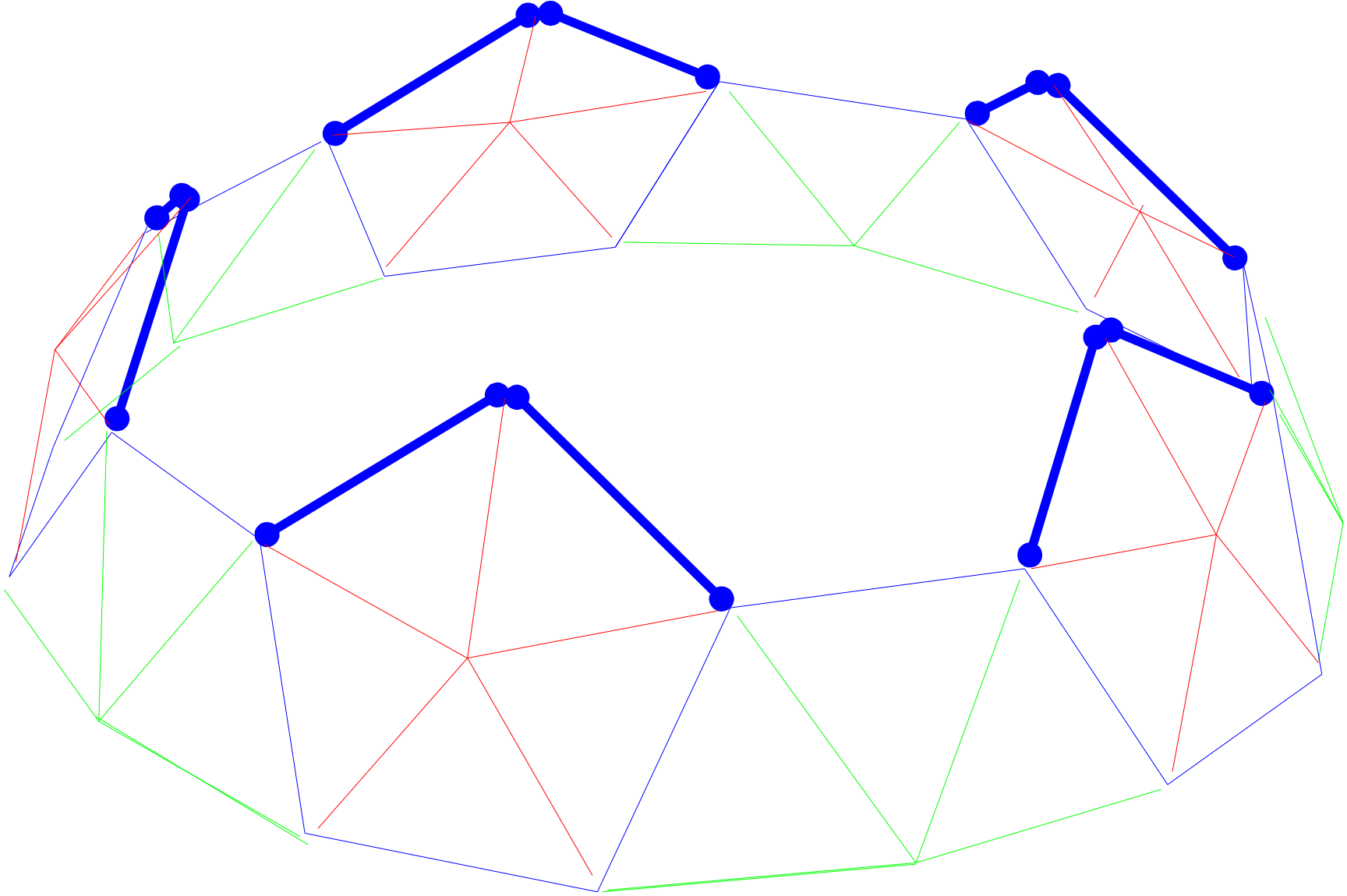

Step 9

Attach x10 -- green tip pipes to form 5 green tip triangles

Attach x5 -- 6 pt hubs to the tops of these 5 green triangles

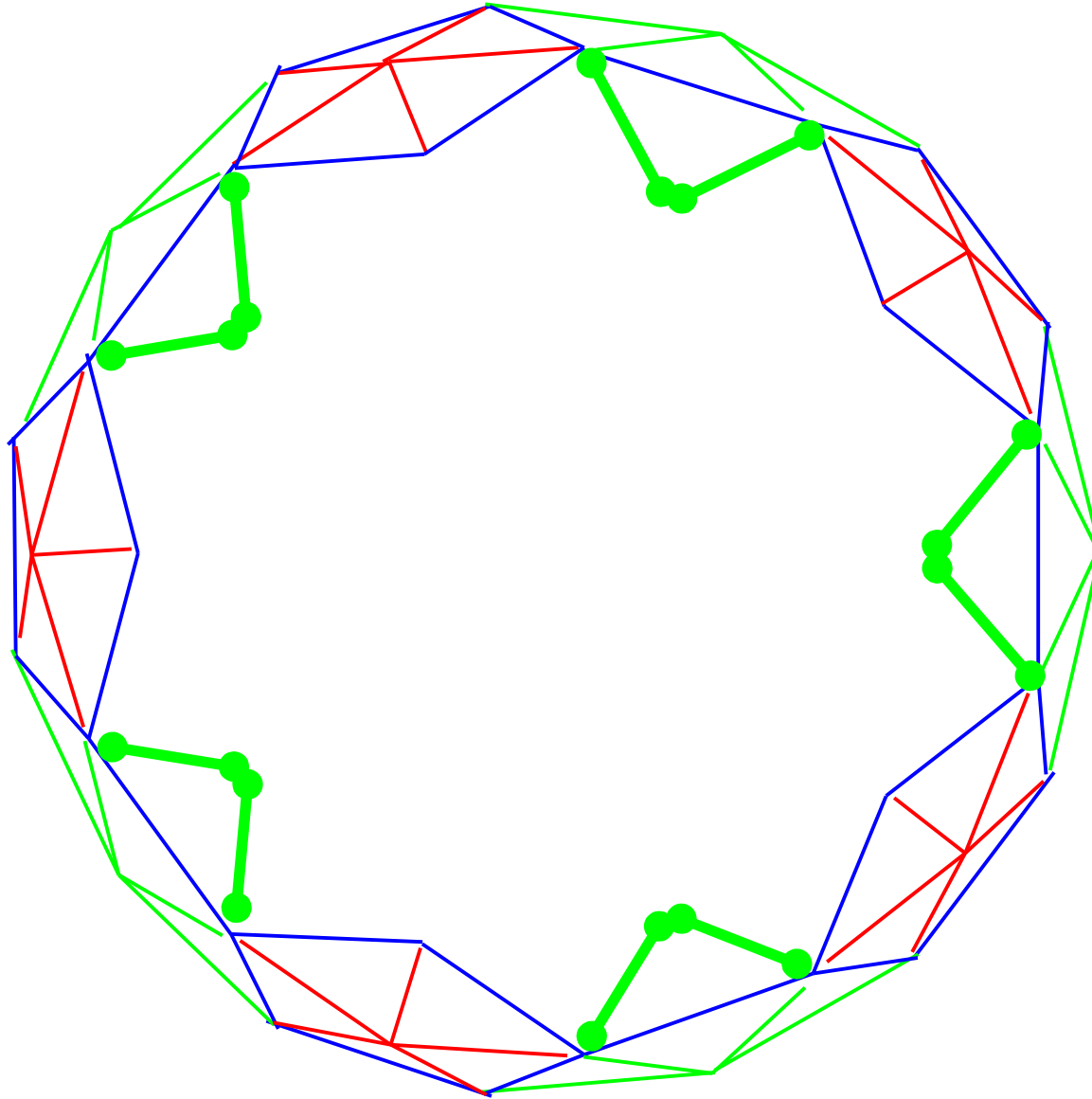

Step 10

Attach x10 -- green tip pipes to bridge together the fourth layer

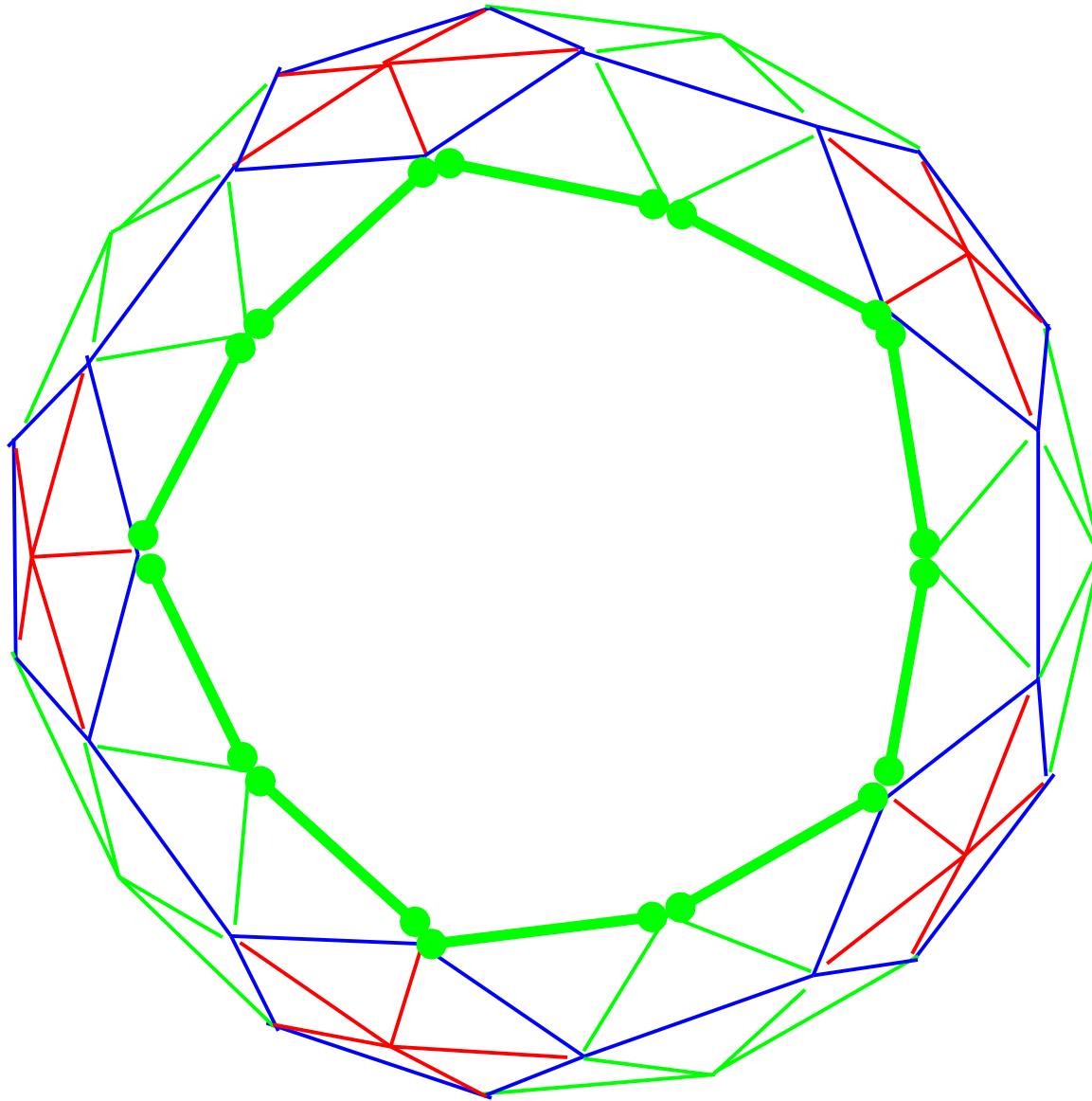

Step 11

attach x5 -- blue tip pipes. They will be parallel with the red pipe in the third layer.

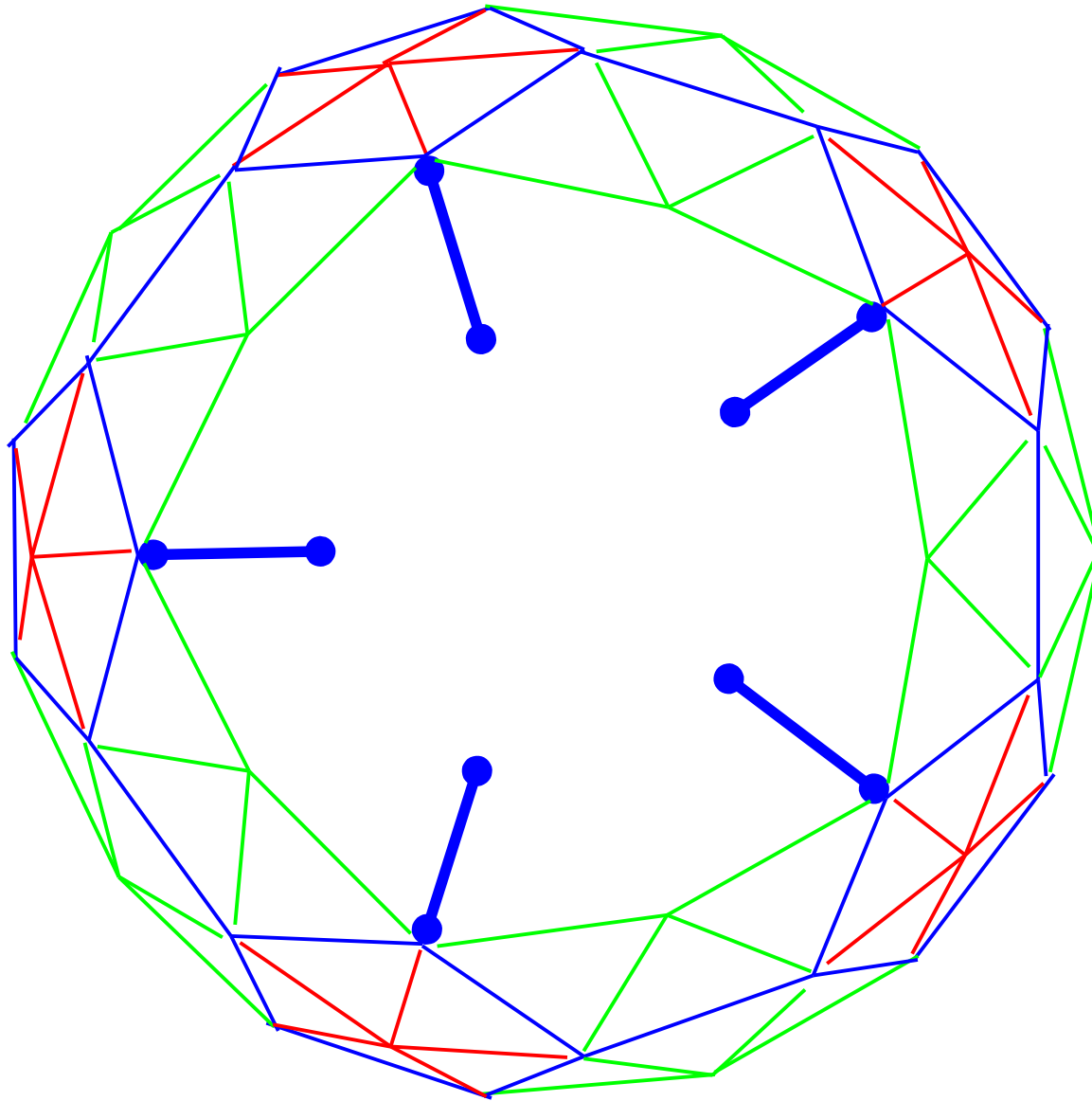

Step 12

attach x10 -- green tip pipes as shown to form five triangles.

Attach x5 -- 6pt hubs to the tops of these triangles.

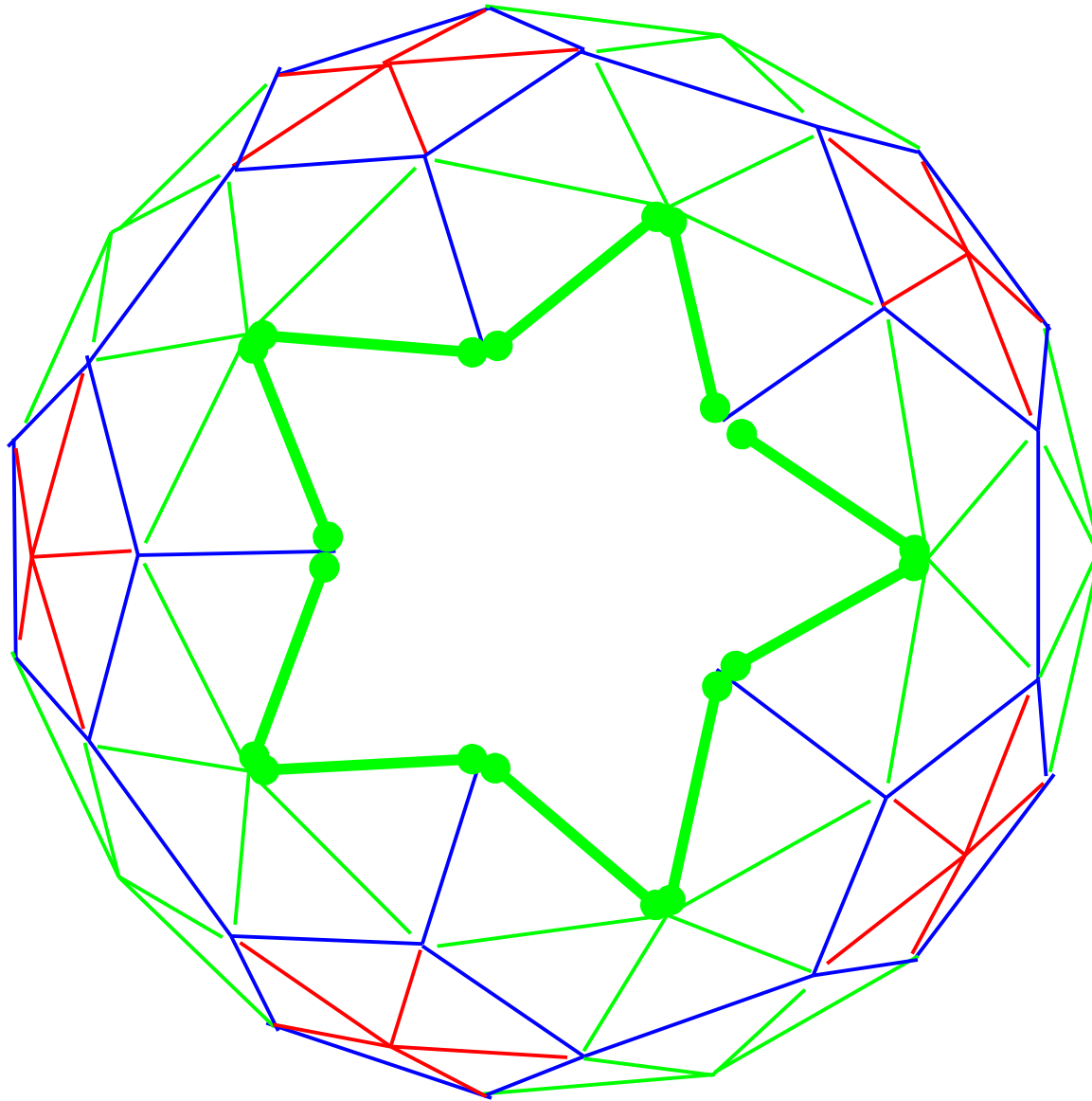

Step 13

Attach x5 -- blue tip pipes to bridge the fifth layer.

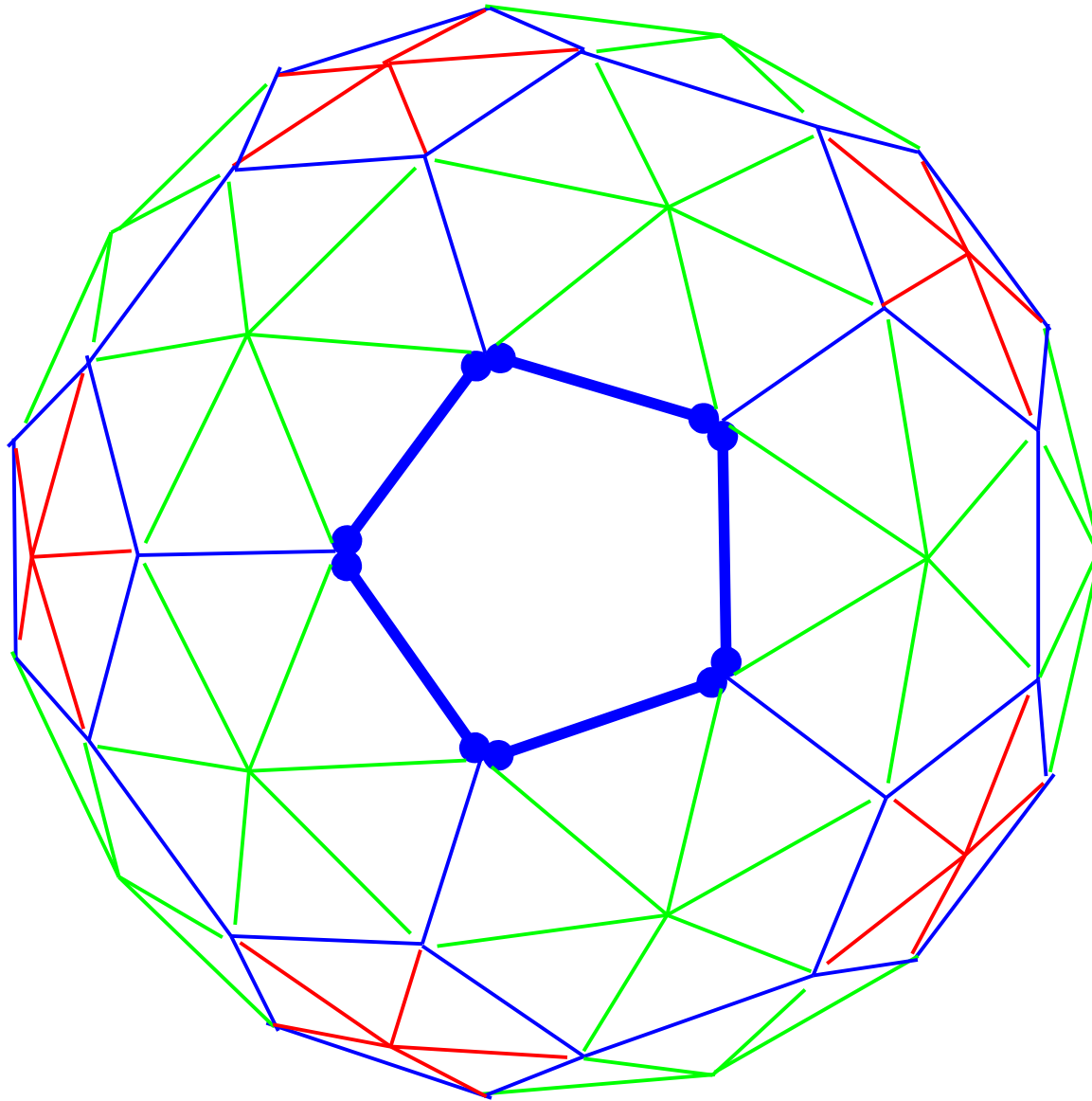

Step 14

attach x5 -- red tip pipes

Attach final 5 pt hub to top of dome

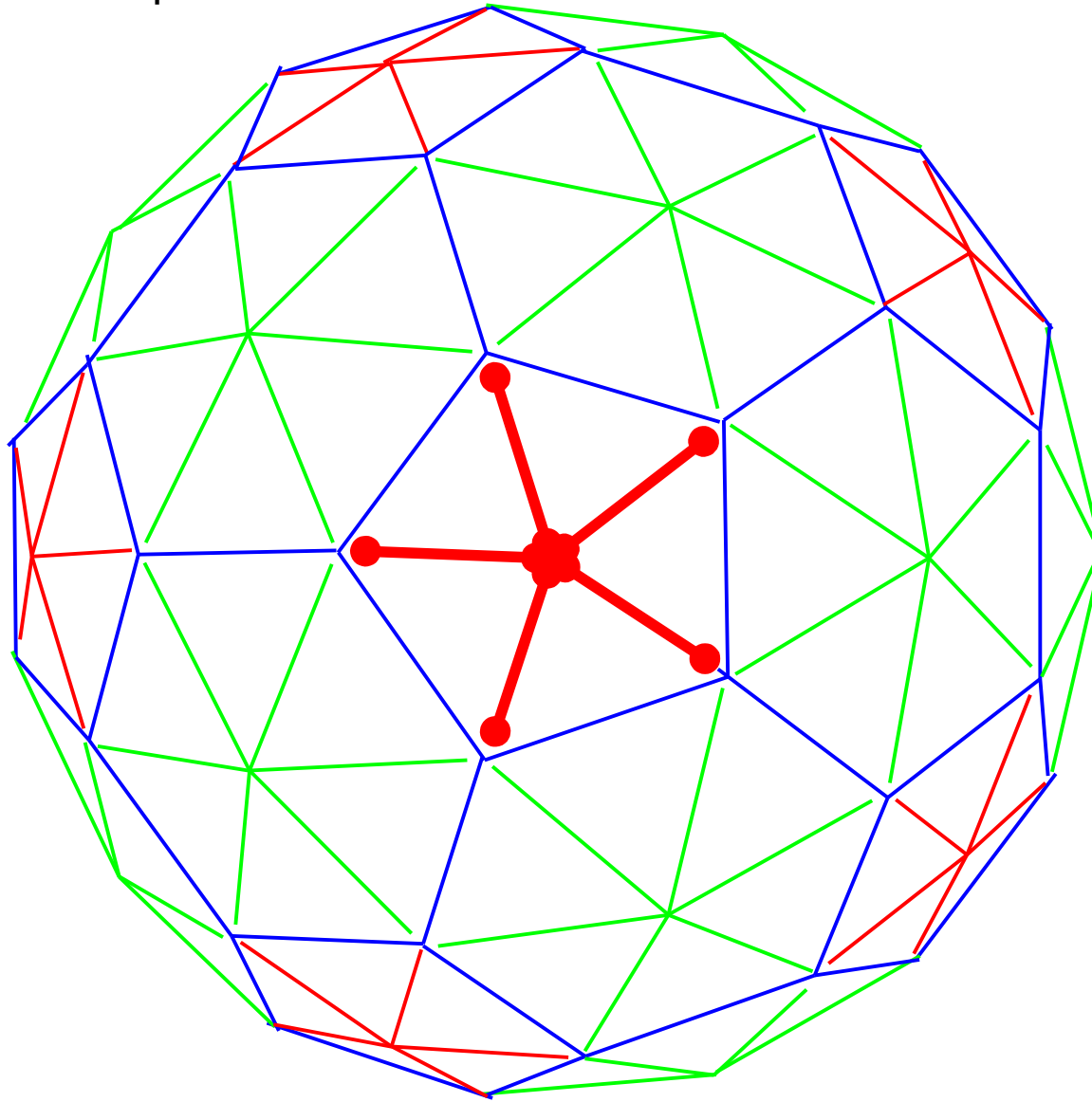

Step 15

Secure all hubs with tension by tightening the nuts starting from the top working around downward. When finished, inspect underneath each hub to ensure the nuts have been tighten.