

### 3 Frequency 5/8 Dome Assembly Instructions

You will need:

A wrench or drill with a 7/16" socket for tightening the bolts

Rubber coated knit gloves (\$3 gloves at Walmart or any Hardware store)

Assembly Time:

5 hours for one person

3 hours for two people

Contents

80 green tip pipes

55 blue tip pipes

30 red tip pipes

**x35 white or blue or purple 6pt hubs**

**x5 orange 6pt hubs**

**x1 orange 5pt hub**

**x5 red 5pt hubs**

**x15 green 4pt hubs**

250+ bolts and nuts

The pvc pipe tip should be attached to the bolt by fitting the hole in the pvc pipe tip over the bolt on the hub. The side with the ink and blue, green or red mark should face towards the inside of the dome. Then a single nut can be used to secure the connection. At first just hand tighten the nut, then after the entire dome is together each bolt should be tightened firm with a hand dill or ratchet. Wearing a snug pair gloves is recommended for tightening the nuts by hand.

There are 6 levels.

- The first level is the ground level where all the green hubs will be used.
- The second level uses all white hubs
- The third level uses the five red hubs and the ten blue hubs.
- The fourth level uses the ten purple hubs.
- The fifth level uses the five six point orange hubs.
- The top apex uses the one five point orange hub.

6-pt hubs x35  
Blue or White or Purple

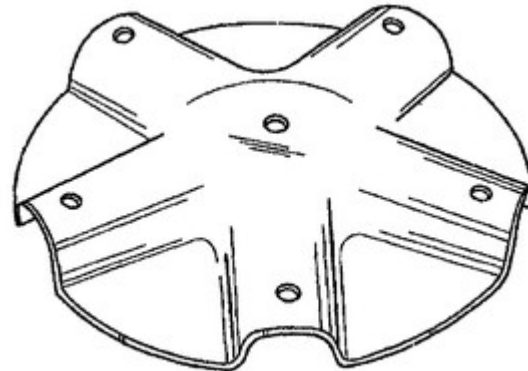
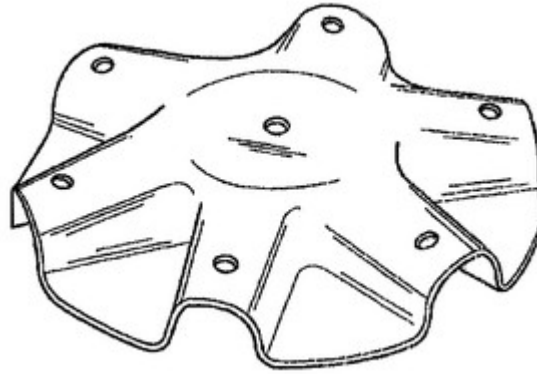

6-pt hubs x5  
Marked Orange  
for top level

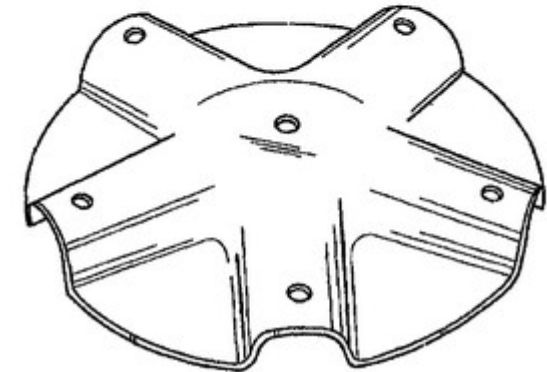
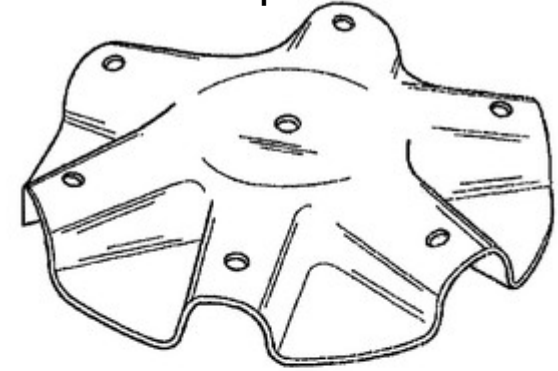

4-pt hubs x15  
Green or White or gray

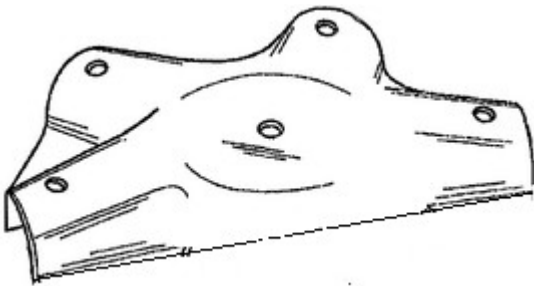

5-pt hubs x5  
marked red

5-pt hubs x1  
marked orange  
top piece

	Pipes	Hubs
# Step 1	10 green tip pipes & 5 blue tip pipes	15 green hubs
# Step 2	10 blue tip pipes	
# Step 3	20 green tip pipes	15 white hubs
# Step 4	5 blue tip pipes	
# Step 5	10 green tip pipes	
# Step 6	10 blue tip pipes	
# Step 7	10 red tip pipes	5 red hubs
# Step 8	10 green tip pipes	10 blue hubs
# Step 9	10 red tip pipes	
# Step 10	5 blue tip pipes	
# Step 11	5 red tip pipes	
# Step 12	10 blue tip pipes	5 purple hubs
# Step 13	10 green tip pipes	5 purple hubs
# Step 14	10 green tip pipes	
# Step 15	5 blue tip pipes	
# Step 16	10 green tip pipes	5 orange 6pt hubs
# Step 17	5 blue tip pipes	
# Step 18	5 red tip pipes	1 orange 5pt hub

## Step 1

### Set aside

- 10 green tip pipes
- 5 blue tip pipes
- 15 green 4pt hubs

Attach the pipes to the hubs by inserting the bolt on the hub into the hole on the tip of the pipe. Then place a nut on the bolt to secure the pipe to the hub. The nut should only be finger tightened onto the bolt. You will tighten them later with a drill or ratchet after all the hubs and struts have been assembled.

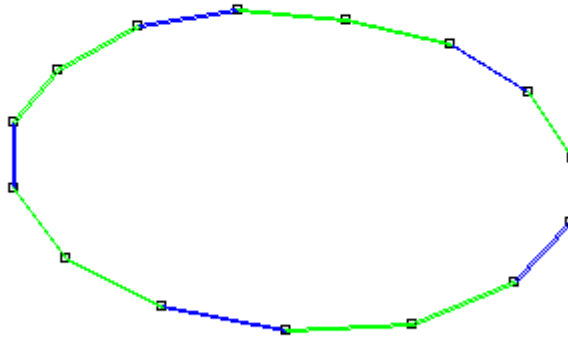

Step 2  
10 blue tip pipes

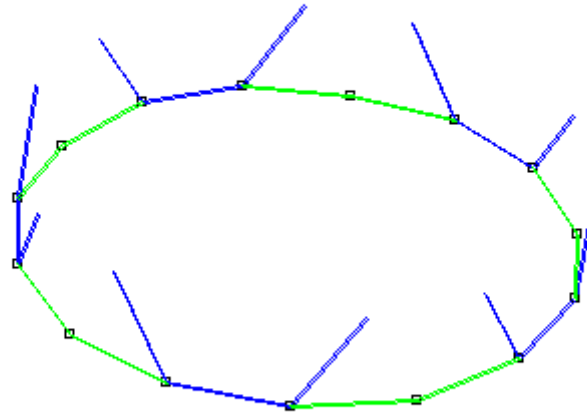

Step 3  
20 green tip pipes  
15 white hubs

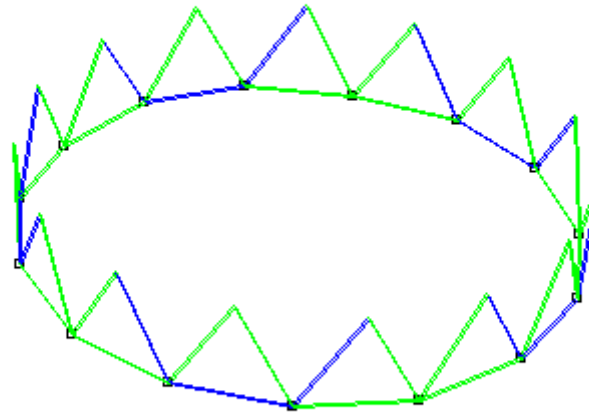

Step 4  
5 blue tip pipes

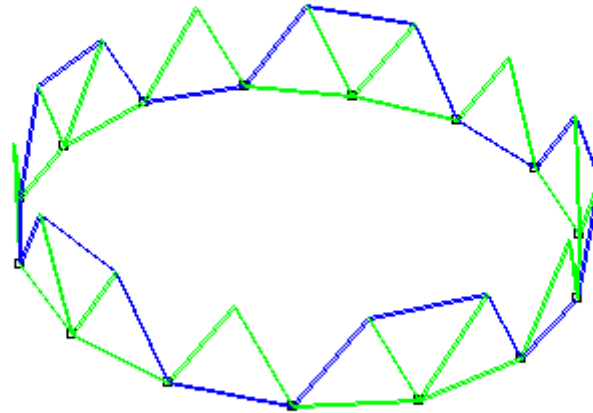

Step 5  
10 green tip pipes

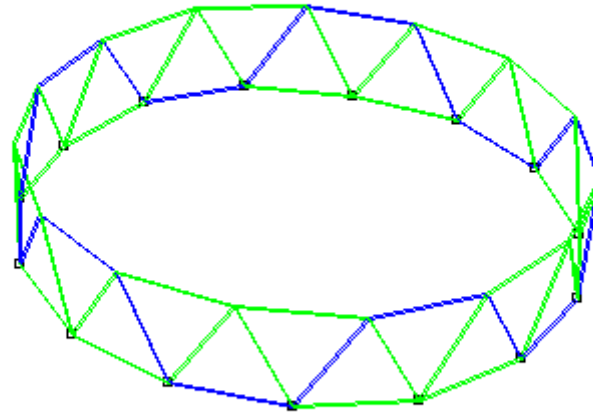

# Step 6  
10 blue tip pipes

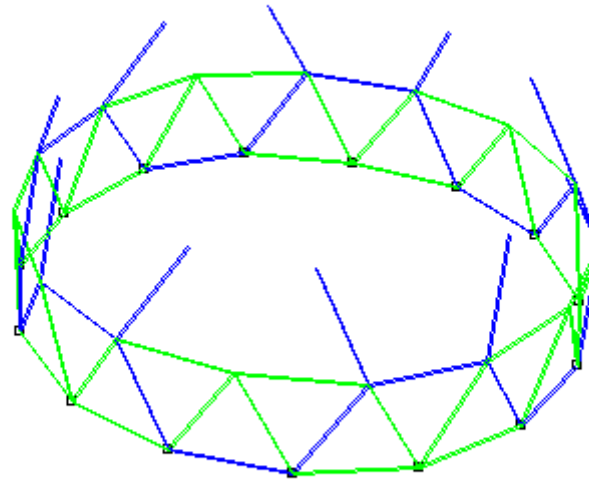

## # Step 7

Set aside

- 5 red “5-point” hubs
- 10 red pipes

Attach the 10 red pipes to the tops of the 4-point hubs above the blue pipes. This will form 5 triangles. Attach the 5 “5 point” hubs to the tops of the triangles.

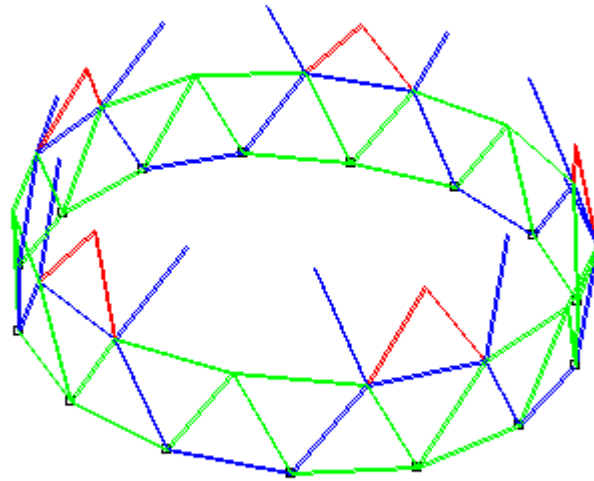

# Step 8  
10 green tip pipes  
10 blue hubs

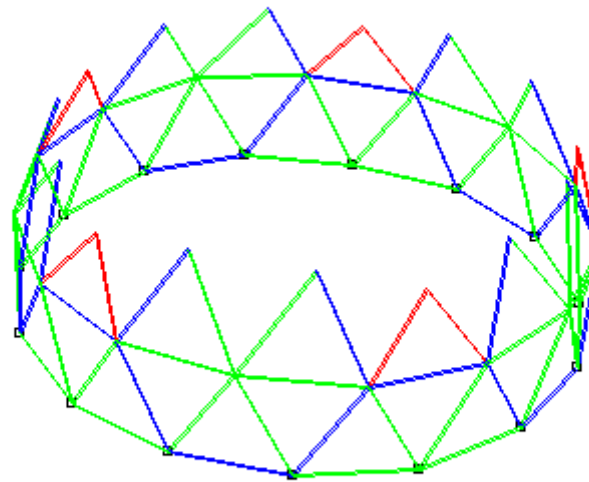

# Step 9  
10 red tip pipes

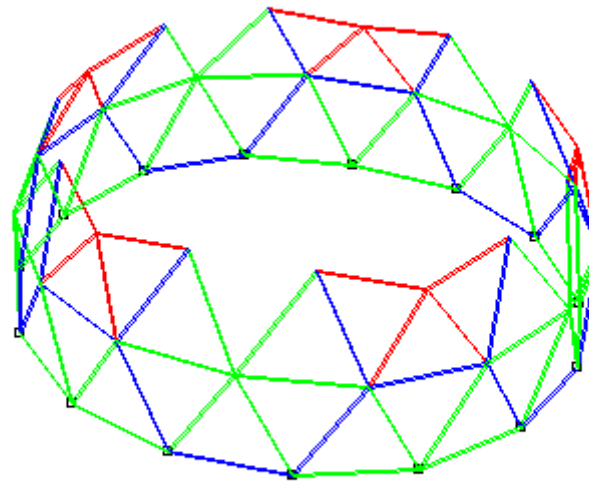

# Step 10  
5 blue tip pipes

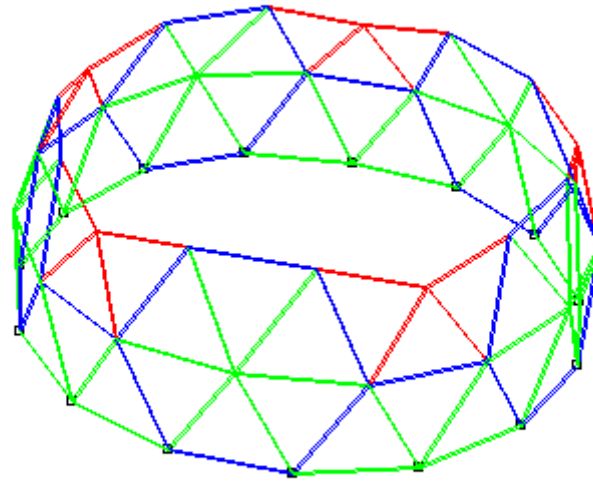

# Step 11  
5 red tip pipes

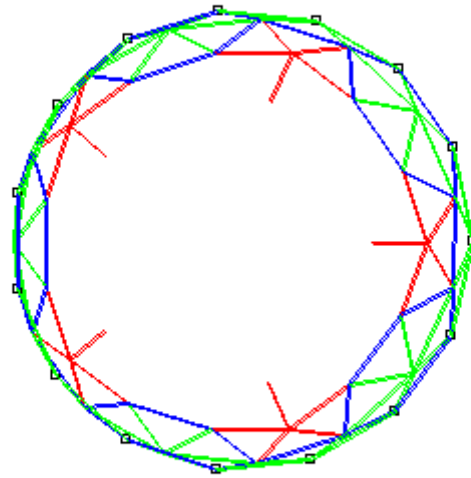

# Step 12  
10 blue tip pipes 5 purple hubs

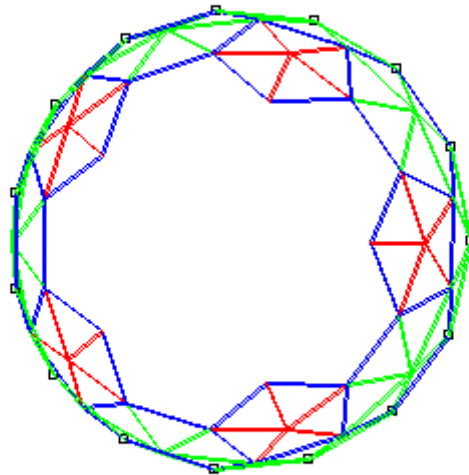

# Step 13  
10 green tip pipes  
5 purple hubs

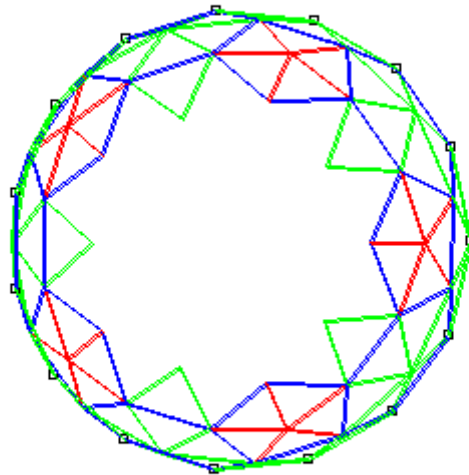

# Step 14  
10 green tip pipes

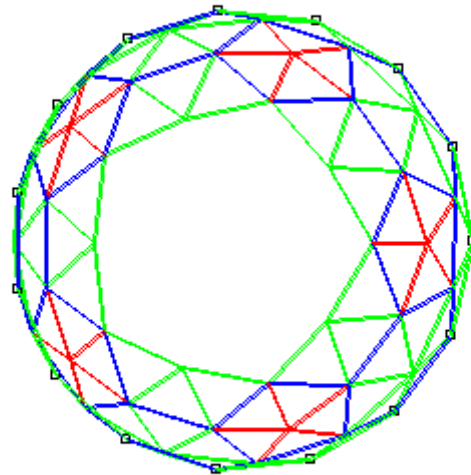

# Step 15  
5 blue tip pipes

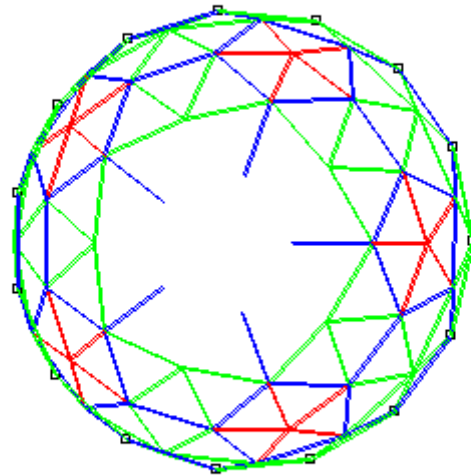

# Step 16  
10 green tip pipes  
5 orange 6pt hubs

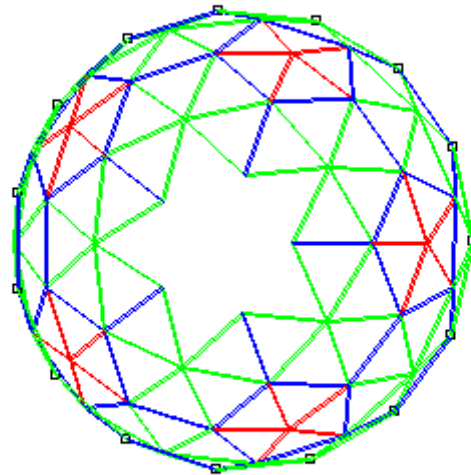

# Step 17  
5 blue tip pipes

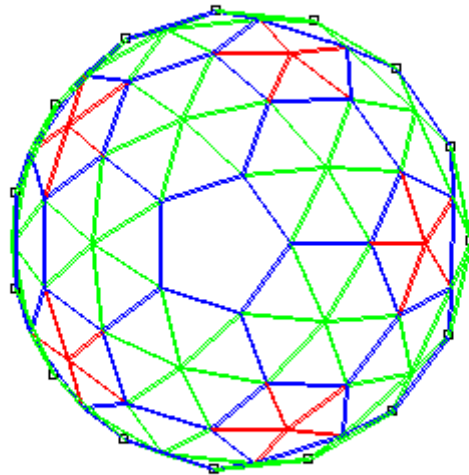

# Step 18  
5 red tip pipes  
1 orange 5pt hub

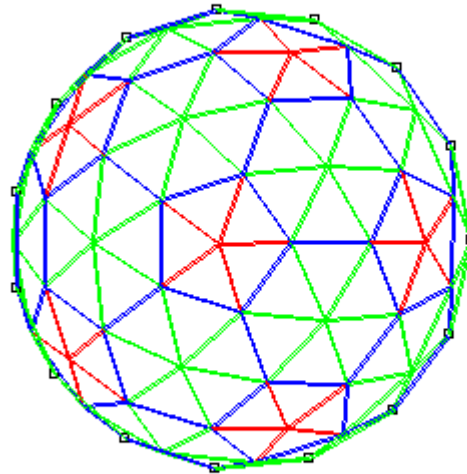

Final Step

Tighten all the nuts with a drill or ratchet using a 7/16 socket.

Start with the bottom layer and work your way to the top tightening all nuts on each hub. After you are finished, double check that all nuts are tight.