

## 2 Frequency Dome Assembly Instructions

You will need:

A wrench or drill with a 7/16" socket for tightening the b

Assembly Time:

2 hours for one person

1 hours for two people

### Contents

65 poles or Pipes using 1 inch diameter PVC pipe

35 longer red poles

30 shorter blue poles

26 Center Units

10 –blue or white “6 point” units

10 – green or yellow “4 point” units

6 – red “5 point” units

130 Nuts and Bolt

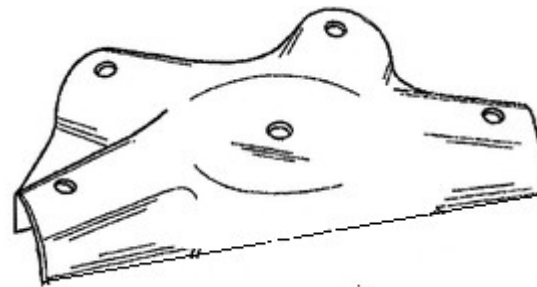

4-point hubs x10  
Green or White or gray

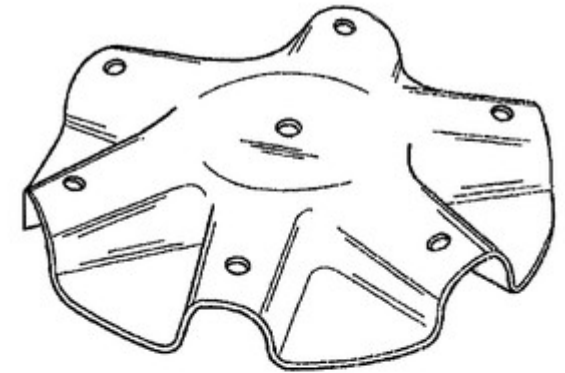

6-point hubs x10  
Blue or White

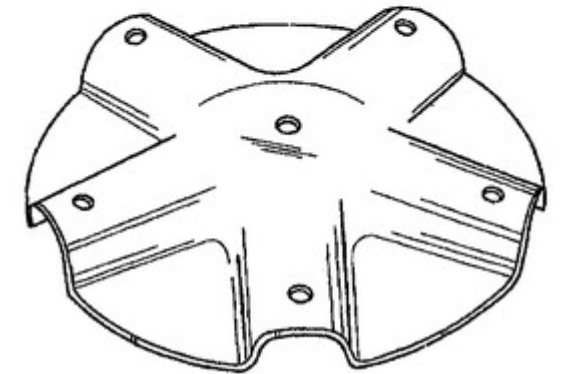

5-point hubs x6  
marked red

The pvc pipe tip should be attached to the bolt by fitting the hole in the pvc pipe tip over the bolt on the hub. The side with the ink and blue or red mark should face towards the inside of the dome. Then a single nut can used to secure the connection. At first just hand tighten the nut, then after the entire dome is together each bolt should be tighten firm with a hand dill or ratchet.

## Ariel View of Final Dome

The red lines represent the longer poles

The blue lines represent the shorter poles

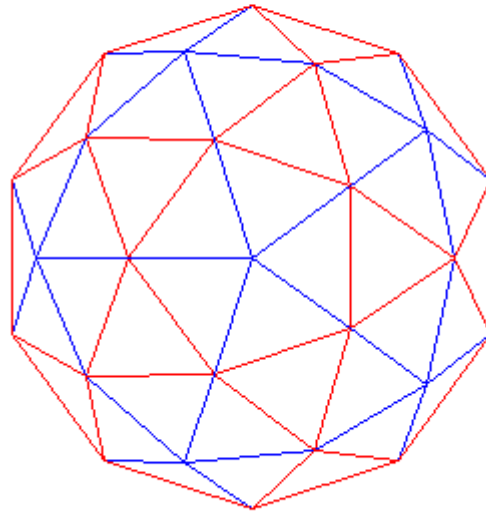

Numbered joints in order of when they are to be assembled  
26 Total Joints  
Joint 0 is made first  
Joint 1 is made second ...  
Joint 25 is made last

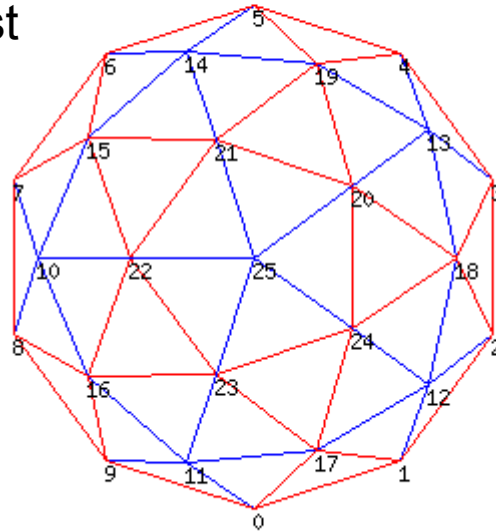

Place 10 long poles in a circle with the 10 green or white 4 point hubs  
Attach the poles together by adding a bolt to the joint  
Just finger tighten the bolt so the bolt stays on but the joint is still a little flexible

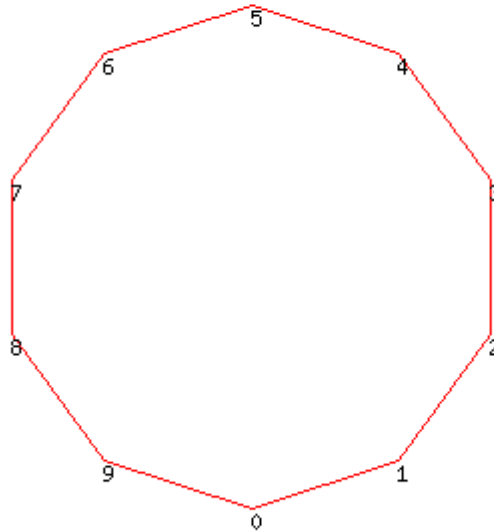

Make ten triangles along the base.

Just hand tighten the bolts. All the bolts will be tighten firm after the entire dome is put together and all the poles are joined together.

5 triangles will be from the short BLUE poles with 5 RED 5 point hubs

5 triangles will be from the long RED poles with 5 white or blue 6 point hubs

***Its easy to get mixed up the at this point, but just make sure the red hubs attach to the tops of the blue tip pipes and the blue hubs attach to the top of the red tip pipes.***

You should see ten triangles, 5 smaller ones between 5 taller ones.

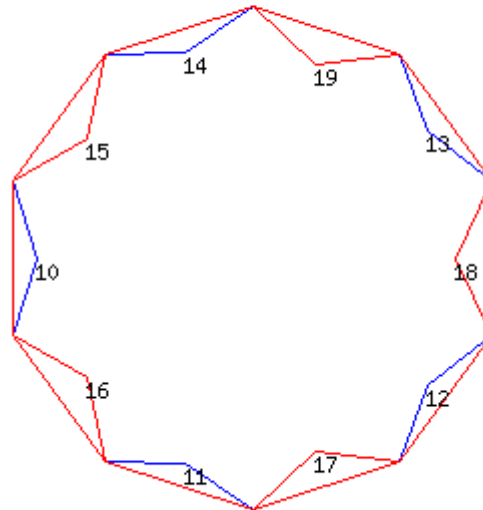

Add ten short blue tip poles to form a second level  
The base triangles do not need to be propped up at this point  
and the poles temporarily holding up the triangles can be removed

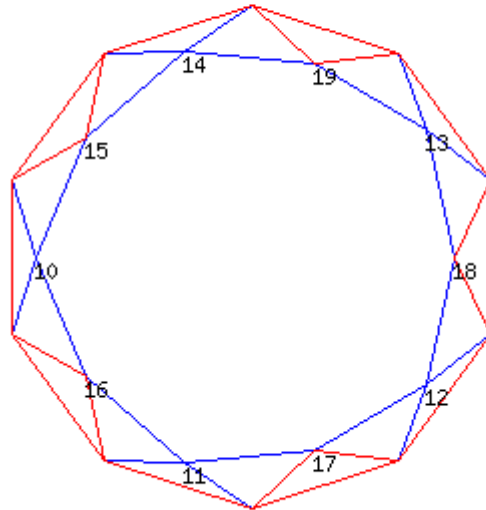

Add five short blue tip poles to the top of the five short pole base triangles.  
These will start the third level.

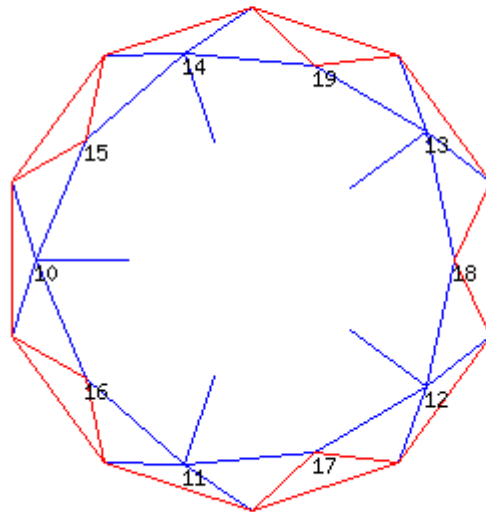

Add ten long poles along with 5 blue or white 6 point hubs.  
These will be connect from the tops of  
five long pole base triangles to the third level

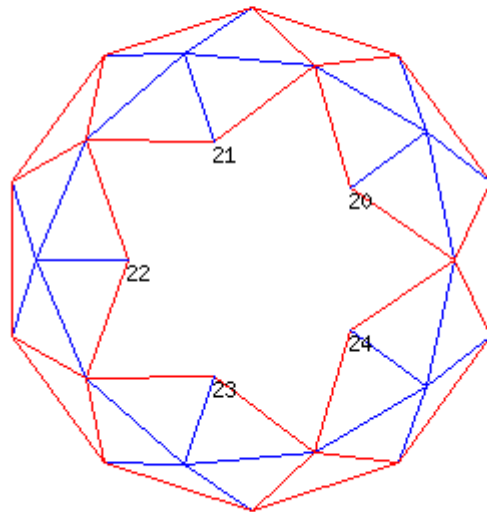



Add five long poles to form the third level

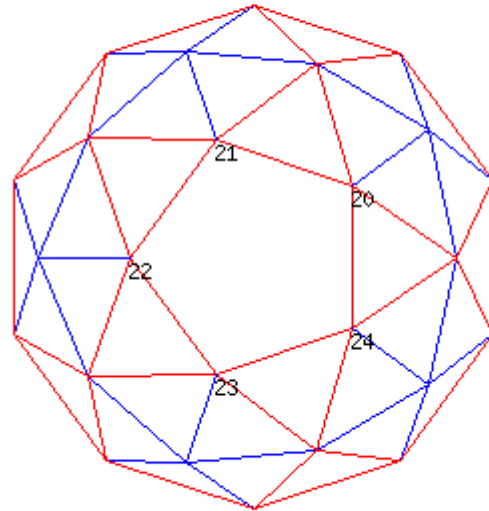

Add five short poles to the third level to the last 5 point red hub  
Connect the five short poles to form the top level or apex of the dome  
The structure is complete.  
The bolts should be tighten firm using a drill or ratchet with a 7/16" socket

